

# JVC®

English

中文

## MICRO COMPONENT SYSTEM

微型组合音响

# UX-A7DVD

—Consists of CA-UXA7DVD and SP-UXA7DVD

—由CA-UXA7DVD 及 SP-UXA7DVD 组成

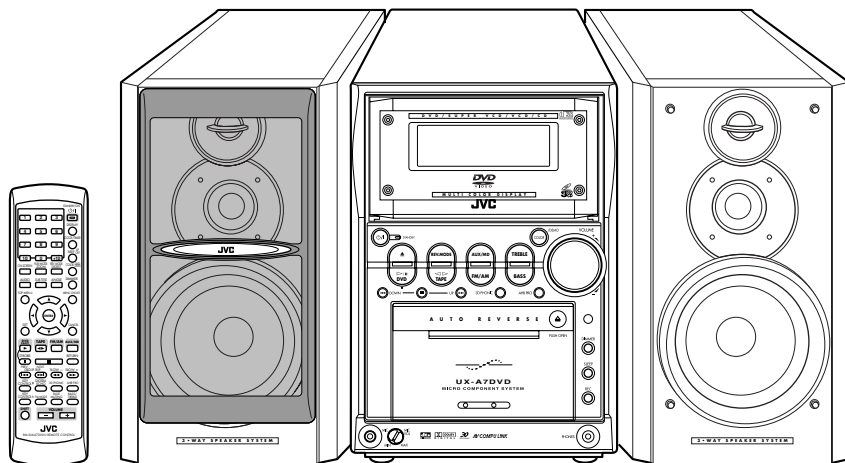

AV COMPU LINK

## INSTRUCTIONS 使用说明书

### For Customer Use:

Enter below the Model No. and Serial No. which are located either on the rear, bottom or side of the cabinet. Retain this information for future reference.

Model No. \_\_\_\_\_

Serial No. \_\_\_\_\_

LVT0954-010A  
[UF]

# Warnings, Cautions and Others

## 警告，注意及其他须知事项

### Caution— button!

Disconnect the mains plug to shut the power off completely. The  button in any position does not disconnect the mains line. The power can be remote controlled.

### 注意— 开关！

无论  开关在任何位置，电源线的电源还是没有被切断，若要将电源完全关闭，应把电源插头拔离插座。电源可用遥控器控制。

### CAUTION

To reduce the risk of electrical shocks, fire, etc.:

1. Do not remove screws, covers or cabinet.
2. Do not expose this appliance to rain or moisture.

### 注意

为了减少触电，火灾等危险：

1. 请勿擅自卸下螺丝钉，盖子或机壳。
2. 请勿让本机受雨淋或置潮湿环境中。

### CAUTION

- Do not block the ventilation openings or holes. (If the ventilation openings or holes are blocked by a newspaper or cloth, etc., the heat may not be able to get out.)
- Do not place any naked flame sources, such as lighted candles, on the apparatus.
- When discarding batteries, environmental problems must be considered and local rules or laws governing the disposal of these batteries must be followed strictly.
- Do not expose this apparatus to rain, moisture, dripping or splashing and that no objects filled with liquids, such as vases, shall be placed on the apparatus.

### 注意

- 请勿堵塞通风口或通风孔。  
(如果通风口或通风孔被报纸或布等堵塞，热量将无法散出。)
- 请勿在本设备上放置任何裸露的火源，如点燃的蜡烛。
- 处理废弃电池时，必须考虑环境问题，并严格遵守当地关于处理废弃电池的有关法律或规定。
- 切勿将本装置暴露于雨水所及、潮湿、滴水或易于溅起水花的地方，亦不要将任何装满液体的物件（如花瓶）放置在本装置上。

### Caution: Proper Ventilation

To avoid risk of electric shock and fire, and to prevent damage, locate the apparatus as follows:

- 1 Front: No obstructions and open spacing.
- 2 Sides/ Top/ Back: No obstructions should be placed in the areas shown by the dimensions below.
- 3 Bottom: Place on the level surface. Maintain an adequate air path for ventilation by placing on a stand with a height of 10 cm or more.

### 注意：正确通风

为免发生触电和火警的危险，及防止本机受损，请将本机如下放置：

1. 前面： 没有障碍物及地方开阔。
2. 侧面/顶面/背面： 在图中所示范围中，不应放置任何障碍物。
3. 底部： 放置在水平面上。放置在一个高 10 厘米或以上的台上，以保持足够的通风道。

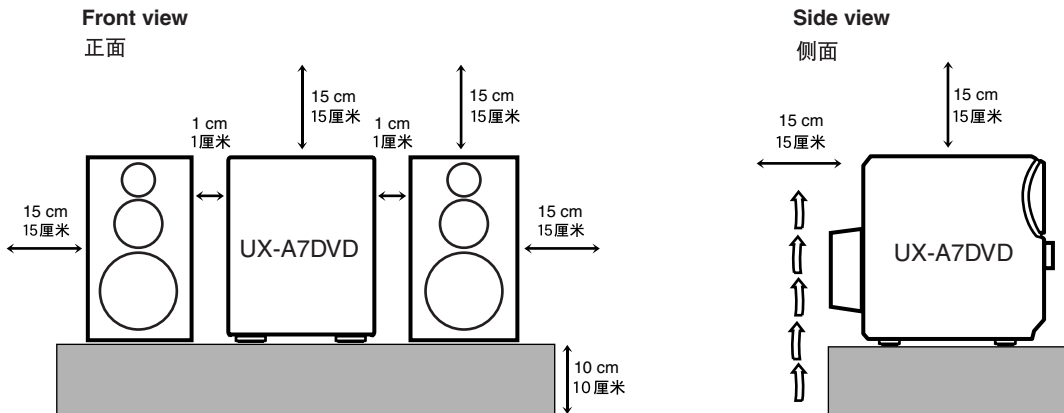

## IMPORTANT FOR LASER PRODUCTS / 镭射产品的重要说明

---

### REPRODUCTION OF LABELS / 说明文抄录

#### ① CLASSIFICATION LABEL ON EXTERIOR SURFACE

##### ① 位于机表的分类说明文

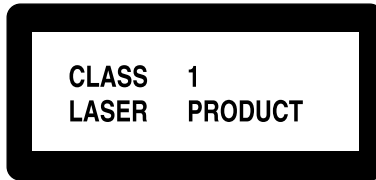

#### ② WARNING LABEL INSIDE THE UNIT

##### ② 位于机内的警告说明文

<b>CAUTION</b> : Visible and invisible laser radiation when open and interlock failed or defeated. AVOID DIRECT EXPOSURE TO BEAM. (e)	<b>ADVARSEL</b> : Synlig og usynlig laserstråling når maskinen er åben eller interlocken fejler. Undgå direkte eksponering til stråling. (d)	<b>VARNING</b> : Synlig och osynlig laserstråling när den öppnas och spärren är urkopplad. Betrakta ej strålen. (s)	<b>VARO</b> : Avattaessa ja suojalukitus ohitettuna tai viallisena olet alttiina näkyvälle ja näkymättömälle lasersäteilylle. Vältä säteen kohdistumista suoraan itseesi. (f)
---	--	---	---

1. CLASS 1 LASER PRODUCT
2. **CAUTION**: Visible and invisible laser radiation when open and interlock failed or defeated. Avoid direct exposure to beam.
3. **CAUTION**: Do not open the top cover. There are no user serviceable parts inside the unit; leave all servicing to qualified service personnel.

1. 一级雷射产品
2. **注意**：当内部锁定装置失效或者损坏后，打开盖板可能会产生可见或不可见的雷射辐射。应避免受到雷射光线的直接照射。
3. **注意**：请勿打开顶盖板。本机内部没有用户可自行维修的部件；所有维修工作应由有资格的人员完成。



# Introduction

We would like to thank you for purchasing one of our JVC products. Before operating this unit, read this manual carefully and thoroughly to obtain the best possible performance from your unit, and retain this manual for future reference.

## About This Manual

This manual is organized as follows:

- This manual mainly explains playback and editing operations using the remote control, and other operations such as recording using the buttons on the main unit. You can use the buttons both on the remote control and on the main unit for the same operations if they have the same or similar names (or marks), unless mentioned otherwise.
- Basic and common information that is the same for many functions is grouped in one place, and is not repeated for each procedure. For instance, we do not repeat the information about turning on/off the unit, setting the volume, changing the sound effects, and others, which are explained in the section “Basic and Common Operations” on pages 18 to 23.
- The following symbols are used in this manual:

	<p>Gives you warning and caution to prevent damage or risk of fire/electric shock. Furthermore, gives you information which is not good for obtaining the best possible performance from the unit.</p>
	<p>Gives you information and hints you had better know.</p>

## Precautions

### Installation

- Install in a place which is level, dry and neither too hot nor too cold—between 5°C and 35°C.
- The unit is equipped with the cooling fan which makes possible the high-powered operations with the limited space. When the temperature inside the unit increases due to operating the unit at high volume or consecutively, the cooling fan activates to lower the temperature. Install the unit in a location with adequate ventilation to prevent internal heat buildup in the unit.
- Leave sufficient distance between the unit and the TV.

- Although the speakers are magnetically shielded, the TV may be mottled. In this case, keep the distance from the speakers to the TV until the speakers does not affect the TV.



DO NOT install the unit in a location near heat sources, or in a place subject to direct sunlight, excessive dust or vibration.

### Power sources

- When unplugging the unit from the wall outlet, always pull on the plug, not the AC power cord.



DO NOT handle the AC power cord with wet hands.

### Moisture condensation

Moisture may condense on the lenses inside the unit in the following cases:

- After starting to heat the room
  - In a damp room
  - If the unit is brought directly from a cold to a warm place
- Should this occur, the unit may malfunction. In this case, leave the unit turned on for a few hours until the moisture evaporates, unplug the AC power cord, then plug it in again.

### Others

- The electronic swing panel may malfunction when you use this unit under intense light such as sunlight.



DO NOT expose this unit to intense light.

- Should any metallic object or liquid fall into the unit, unplug the AC power cord and consult your dealer before operating any further.
- If you are not going to operate the unit for an extended period of time, unplug the AC power cord from the wall outlet.



DO NOT disassemble the unit since there are no user serviceable parts inside.

If anything goes wrong, unplug the AC power cord and consult your dealer.

# Contents

<b>Location of the Buttons and Controls</b> .....	<b>3</b>	<b>Playing Back Tapes</b> .....	<b>40</b>
Main Unit .....	3	Playing Back a Tape .....	41
Remote Control .....	5	<b>Special Disc Playback</b> .....	<b>42</b>
<b>About Discs</b> .....	<b>6</b>	Locating a Scene by Selecting the Chapter Number	
Playable Disc Types .....	6	—Chapter Search .....	43
Disc Structure .....	7	Locating a Position by Selecting the Playing Time	
<b>Getting Started</b> .....	<b>8</b>	—Time Search .....	43
Unpacking .....	8	Viewing the Desired Chapters/Tracks—Digest .....	44
Putting the Batteries into the Remote Control .....	8	Selecting Multi-Angle Views .....	45
Connecting Antennas .....	8	Selecting the Audio Language or Sound .....	46
Connecting Speakers .....	9	Selecting the Subtitle Language .....	46
Connecting a TV .....	10	Playing a Still Picture/Frame-by-Frame .....	47
Connecting Other Equipment .....	11	Showing Continuous Still Pictures—Strobe .....	47
Setting the DVD Player .....	13	Playing Back in Slow-Motion—Slow .....	47
Setting the Clock .....	17	Zooming in the Picture—Zoom .....	48
<b>Basic and Common Operations</b> .....	<b>18</b>	Enjoying Virtual Surround Sound—3D PHONIC .....	48
Turning On the Power .....	19	<b>Recording</b> .....	<b>49</b>
Selecting the Sources and Starting Play .....	20	Before You Start Recording on a Tape .....	50
Adjusting the Volume .....	20	Recording a Disc onto a Tape	
Reinforcing the Bass Sound .....	21	—Disc Synchronized Recording .....	51
Adjusting the Tone .....	21	Recording Other Sources onto a Tape .....	52
Changing the Display Illumination .....	22	<b>Using the Microphone</b> .....	<b>53</b>
Adjusting the Audio Input Level .....	23	Singing Along (Karaoke) .....	54
Prohibiting Disc Ejection .....	23	<b>Changing the DVD Initial Settings</b> .....	<b>55</b>
<b>Listening to FM and AM Broadcasts</b> .....	<b>24</b>	Basic Procedure .....	56
Setting the AM Tuner Interval Spacing .....	25	Changing the Initial Language Settings .....	57
Tuning in to a Station .....	25	Changing the Various Audio Settings .....	57
Presetting Stations .....	26	Changing the Display Settings .....	58
Tuning in to a Preset Station .....	26	Changing the System Settings .....	58
<b>Playing Back Discs</b> .....	<b>27</b>	Limiting Playback of DVD—Parental Lock .....	59
Loading a Disc .....	28	<b>Using the Timers</b> .....	<b>60</b>
DVD Basic Operations .....	29	Using the Recording Timer .....	61
SVCD/VCD/Audio CD Basic Operations .....	30	Using the Daily Timer .....	62
MP3 Basic Operations .....	32	Using the Sleep Timer .....	64
Searching for a Particular Point .....	33	<b>Using AV COMPU LINK Control System</b> ...	<b>65</b>
Playing Back by Using the Disc Menu .....	34	<b>Maintenance</b> .....	<b>66</b>
Repeating Playback .....	35	<b>Troubleshooting</b> .....	<b>67</b>
Programming the Playing Order—Program Play .....	37	<b>Table of Language Codes</b> .....	<b>69</b>
Playing at Random—Random Play .....	39	<b>Table of Country/Area Codes</b> .....	<b>70</b>
		<b>Specifications</b> .....	<b>72</b>

# Location of the Buttons and Controls

Become familiar with the buttons and controls on your unit.

## Main Unit

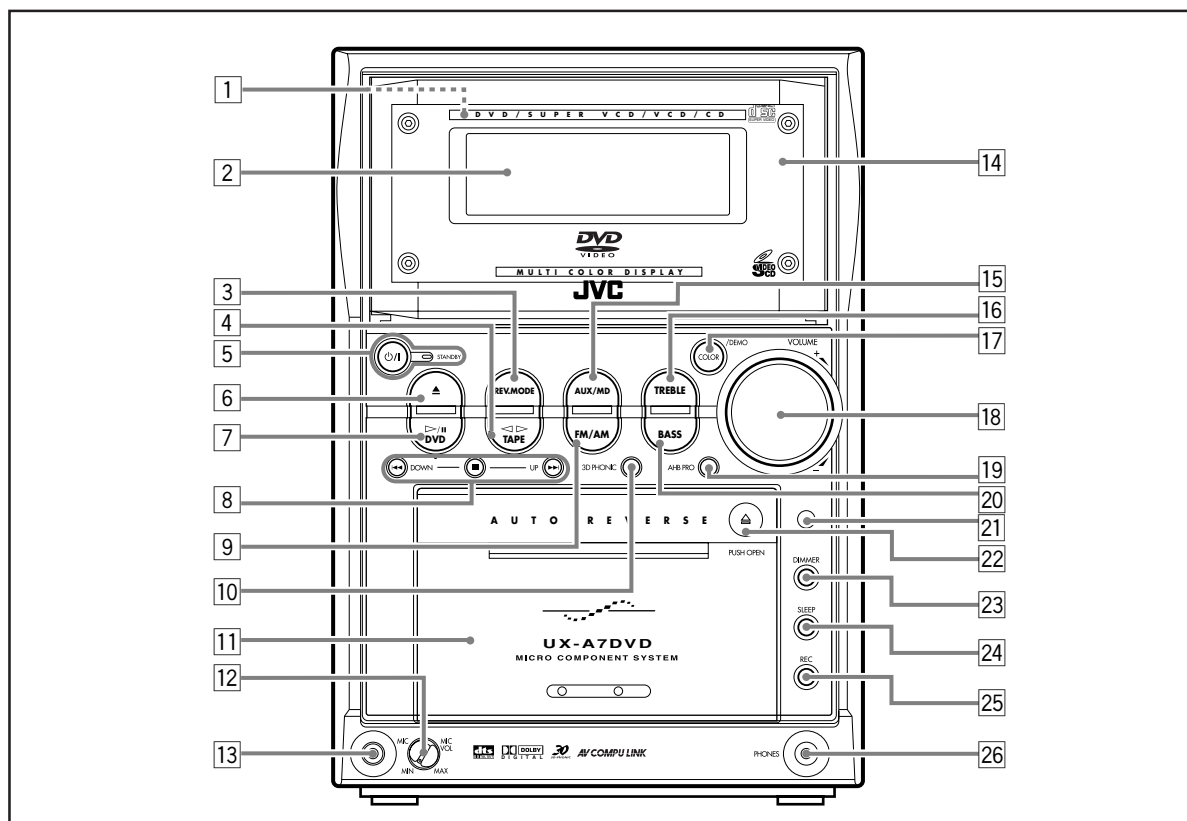

### Main unit

See pages in parentheses for details.



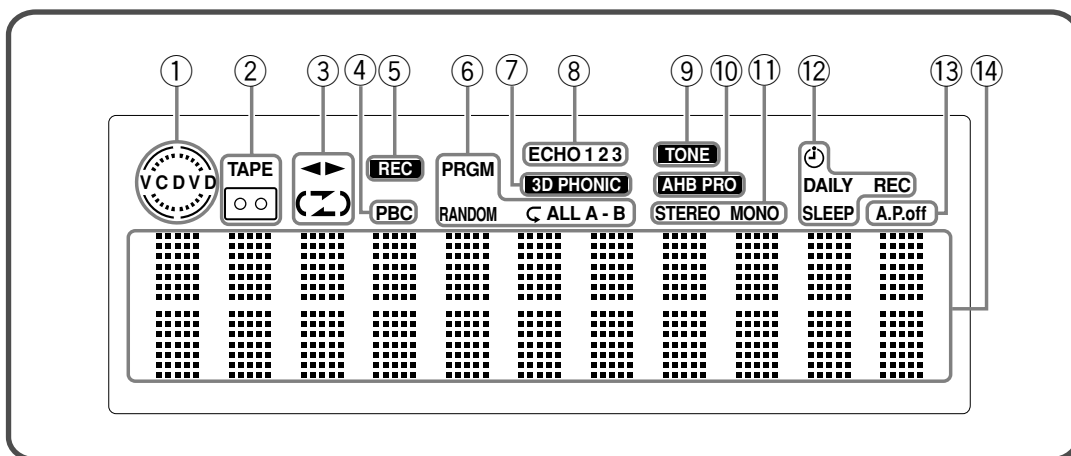

- |  |   |
|--|---|
| 1 Disc tray (inside the electronic swing panel) (28)   | 10 3D PHONIC button (48)                                |
| 2 Display window (4)   | 11 Cassette holder (41)                                 |
| 3 REV. MODE button (23, 41, 51, 52, 61)  | 12 MIC VOL (volume) control (54)                        |
| 4 TAPE <▷> (play) button (19, 20, 41)  | 13 MIC jack (54)  |
| • Pressing this button also turns on the unit.   | 14 Electronic swing panel                               |
| 5 ⏻ (Standby/On) button and STANDBY lamp (19, 25, 62, 63)  | 15 AUX/MD button (19, 20, 23, 52)                       |
| • Pressing this button also turns on the unit.   | • Pressing this button also turns on the unit.          |
| 6 DVD ▲ (eject) button (19, 28, 29, 58, 59)  | 16 TREBLE button (21)                                   |
| • Pressing this button also turns on the unit.   | 17 COLOR/DEMO button (12, 22)                           |
| 7 DVD ▷/   (play/pause) button (19, 20, 28 – 33, 51, 58)   | 18 VOLUME + / – control (20, 21, 54)                    |
| • Pressing this button also turns on the unit.   | 19 AHB PRO (Active Hyper Bass Pro) button (21)          |
| 8 Multi operation buttons  | 20 BASS button (21)                                     |
| • DOWN and UP buttons  | 21 Remote sensor (4)                                    |
| • ◀◀ (reverse search/fast-wind to the left), ■ (stop) and ▶▶ (forward search/fast-wind to the right) buttons | 22 △ (PUSH OPEN) (41)                                   |
| 9 FM/AM button (19, 20, 25, 52)  | • Push this mark to open and close the cassette holder. |
| • Pressing this button also turns on the unit.   | 23 DIMMER button (22)                                   |
|  | 24 SLEEP button (64)                                    |
|  | 25 REC button (51, 52)                                  |
|  | 26 PHONES jack (20)                                     |

## Display window on the electronic swing panel



### Display window

See pages in parentheses for details.

- ① Disc indicator (28)
- ② TAPE  indicator (41)
- ③ Tape operation indicators (41, 51, 52, 61)
  - ◀▶ (tape direction) and  (reverse mode)
- ④ PBC indicator (30, 34)
- ⑤ REC indicator (51, 52)
- ⑥ Disc play mode indicators (36 – 39)
  - PRGM (program), RANDOM, Repeat mode (, )
- ⑦ 3D PHONIC indicator (48)
- ⑧ ECHO indicator (54)
- ⑨ TONE indicator (21)
- ⑩ AHB PRO (Active Hyper Bass Pro) indicator (21)
- ⑪ FM mode indicators (25)
  - STEREO and MONO
- ⑫ Timer mode indicators
  -  (timer) (61 – 64)
  - DAILY (Daily Timer) (62, 63)
  - REC (Recording Timer) (61, 62)
  - SLEEP (Sleep Timer) (64)
- ⑬ A.P.off (Auto Power off) indicator (19)
- ⑭ Main display
  - Shows the source name and other information.

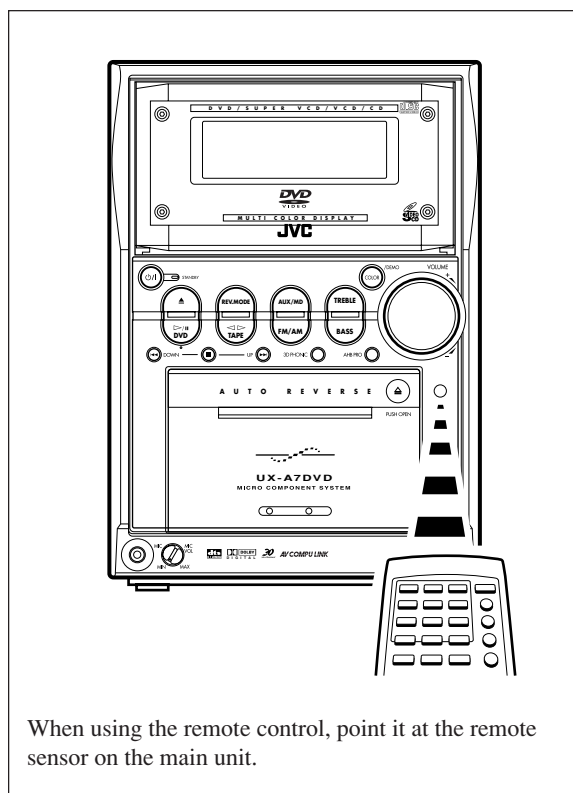

When using the remote control, point it at the remote sensor on the main unit.

## Remote Control

See pages in parentheses for details.

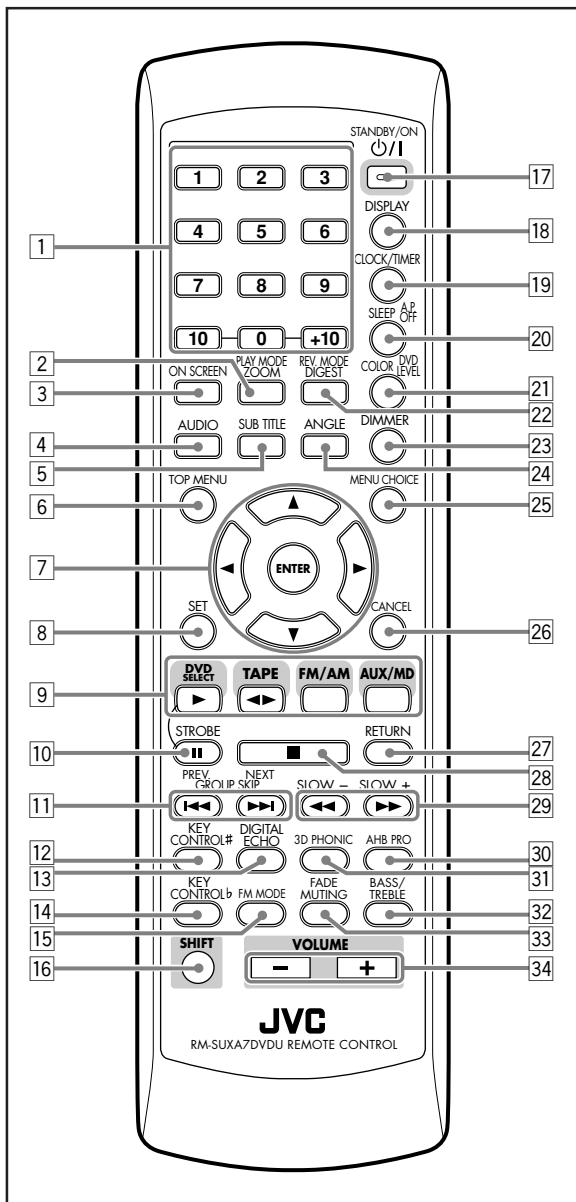

- 1 Number buttons
- 2 PLAY MODE button (35 – 39, 43, 44)  
ZOOM button\* (48)
- 3 ON SCREEN button (29, 31, 33)
- 4 AUDIO button (46)
- 5 SUB TITLE button (46)
- 6 TOP MENU button (34)
- 7 Cursor ◀/▶/▲/▼ and ENTER buttons
- 8 SET button (17, 22, 23, 26, 61 – 64)
- 9 Source selecting buttons
  - DVD SELECT ▶ (play) button (13, 19, 20, 28 – 33, 35, 37, 39, 47, 51, 58)
  - TAPE ◀▶ (play) button (19, 20, 41)
  - FM/AM button (19, 20, 25, 26, 52)
  - AUX/MD button (19, 20, 23, 52)
- Pressing one of these buttons also turns on the unit.*
- 10 || (pause) button (29, 31, 32, 47, 51)  
STROBE button (47)
- 11 ▶▶| and |◀◀ buttons  
GROUP SKIP ▶▶|/|◀◀ buttons\* (33)  
PREV. and NEXT buttons (34, 44)
- 12 KEY CONTROL # button (54)
- 13 DIGITAL ECHO button (54)
- 14 KEY CONTROL b button (54)
- 15 FM MODE button (25)
- 16 SHIFT button
- 17 STANDBY/ON ⏻/⏻ button (19, 62, 63)
- 18 DISPLAY button (17)
- 19 CLOCK/TIMER button (17, 61 – 63)
- 20 SLEEP button (64)  
A.P.OFF button\* (19)
- 21 COLOR button (12, 22)  
DVD LEVEL button\* (30)
- 22 REV. MODE button (41, 51, 52, 61)  
DIGEST button\* (44)
- 23 DIMMER button (22)
- 24 ANGLE button (45)
- 25 MENU button (34)  
CHOICE button\* (14 – 16, 56)
- 26 CANCEL button
- 27 RETURN button (34)
- 28 ■ (stop) button
- 29 ▶▶ and ◀◀ buttons  
SLOW + / – buttons (47)
- 30 AHB PRO (Active Hyper Bass Pro) button (21)
- 31 3D PHONIC button (48)
- 32 BASS/TREBLE button (21)
- 33 FADE MUTING button (20)
- 34 VOLUME + / – buttons (20, 21, 54)







\* These buttons function while pressed with SHIFT.



## Playable Disc Types

This unit has been designed to play back the following discs:

- This unit can also play back MP3 files recorded on CD-Rs and CD-RWs. For in-depth information about MP3, see “MP3 Basic Operations” on page 32.
- We refer to DVD Video as DVD in this manual.

Disc Type	Mark (Logo)	Video Format*2	Region Code*1 Number
DVD VIDEO			3 or ALL
Video CD (VCD)		NTSC or PAL	—
Super Video CD (SVCD)			—
Audio CD		—	—
CD-R		—	—
CD-RW		—	—

In addition to the above discs, this unit can play back audio data recorded on CD Text, CD-G (CD Graphics), and CD-Extra.

- The following discs cannot be played back: DVD Audio, DVD-ROM, DVD-RAM, DVD-RW, DVD-R, CD-ROM, CD-I (CD-I Ready), Photo CD, etc. Playing back these discs will generate noise and damage the speakers.
- On some DVD, SVCD, or VCD, the actual operations may be different from what is explained in this manual, due to the programming and disc structure; such difference are not a malfunction of this unit.

- Continued use of irregular shape discs (heart-shape, octagonal, etc.) can damage the unit.



- The Macrovision's copy protection system is applied to this unit. If you make a copy on your VCR from a disc that is recorded this copy protection signal, the copy cannot be played back normally.

### \*1 Note on Region Code

DVD players and DVDs have their own Region Code numbers. This unit can play back only DVDs recorded with the NTSC or PAL color system whose Region Code numbers include “6.”



If a DVD with the improper Region Code numbers is loaded, “REGION CODE ERROR” appears on the display and playback cannot start.

### \*2 Note on Video Format

- DVDs recorded with the PAL color system cannot be converted into the NTSC color system.
- DVDs recorded with the NTSC color system can be converted into the PAL color system.
- When playing back a SVCD or VCD, the unit can convert both from PAL to NTSC and NTSC to PAL.

### Notes on CD-R and CD-RW

- User-edited CD-Rs (Recordable) and CD-RWs (Rewritable) can be played back only if they have been “finalized.”
- The unit can play back CD-Rs or CD-RWs if they have been recorded in the audio CD format. The unit can also play back CD-Rs or CD-RWs if MP3 files are recorded on them. However, these discs may not play back because of their disc characteristics, recording conditions, damage to the disc.
- Before playing back CD-Rs or CD-RWs, read their instructions or cautions carefully.
- CD-RWs may require a longer readout time, as the reflectance of CD-RWs is lower than for regular CDs.

This product incorporates copyright protection technology that is protected by method claims of certain U.S. patents and other intellectual property rights owned by Macrovision Corporation and other rights owners. Use of this copyright protection technology must be authorized by Macrovision Corporation, and is intended for home and other limited viewing uses only unless otherwise authorized by Macrovision Corporation. Reverse engineering or disassembly is prohibited.

## About audio formats

Some audio formats used on discs are described below:

- **Linear PCM**

Uncompressed digital audio, the same format used on CDs and most studio masters.

DVD supports 2-channels at sampling rates of 48/96 kHz and quantization of 16/20/24 bits.

Audio CD/Video CD is limited to 2-channels at 44.1 kHz at 16 bits.

- **Dolby Digital**

A surround audio format configured with up to six channels. Because the “LFE (Low-Frequency Effect for sub-woofer, etc.)” channel is an auxiliary channel, so this format is called “5.1-channel system.”

Not all Dolby Digital discs contain six (5.1) channel information.

- **DTS (Digital Theater Systems)**

A surround audio format configured with up to six (5.1) channel which is the same as Dolby Digital. Because the compression ratio is lower than for Dolby Digital, it provides wider dynamic range and better separation.

Not all DTS discs contain six (5.1) channel information.

- **MPEG Multichannel**

A surround audio format which can handle the augmentative 7.1-channel format (rare for home use), as well as 5.1-channel.

### IMPORTANT:

- This unit does not provide the DTS decoding function.

The sound signals of DTS are only output through the DVD OPTICAL DIGITAL OUT terminal and are not output through the speakers of this unit.

To listen to the sound of DTS, connect a DTS decoder or an amplifier compatible with DTS.

- To reproduce the multichannel sounds such as Dolby Digital 5.1 ch, DTS Digital Surround and MPEG Multichannel, connect an amplifier or a decoder compatible with these multichannel sources to this unit. (See page 11.)
- Playing back an Audio CD whose sound is encoded with DTS may generate noise and damage the speakers.  
When playing such a disc, turn the volume level on this unit to minimum.

## Disc Structure

A DVD consists of “titles,” and each title may be divided into “chapters.” (See Example 1.)

For example, if a DVD disc contains some movies, each movie may have its own title number, and it may be further divided into chapters.

Example 1: DVD

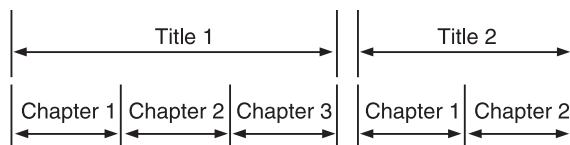

On the other hand, a SVCD, VCD, and Audio CD consist of “tracks.” (See Example 2.)

In general, each track has its own track number. (On some discs, each track may also be divided by Indexes.)

Example 2: SVCD/VCD/Audio CD



## Unpacking

After unpacking, check to be sure that you have all the following items.

The number in parentheses indicates the quantity of each piece supplied.

- FM antenna (1)
- AM loop antenna (1)
- Remote control (1)
- Batteries (2)
- Video cord (1)
- Speaker cords (2)

If any item is missing, consult your dealer immediately.

## Putting the Batteries into the Remote Control

Insert the batteries—R6P(SUM-3)/AA(15F)—into the remote control by matching the polarity (+ and -) on the batteries with the + and - marking on the battery compartment.

When the remote control can no longer operate the unit, replace both batteries at the same time.

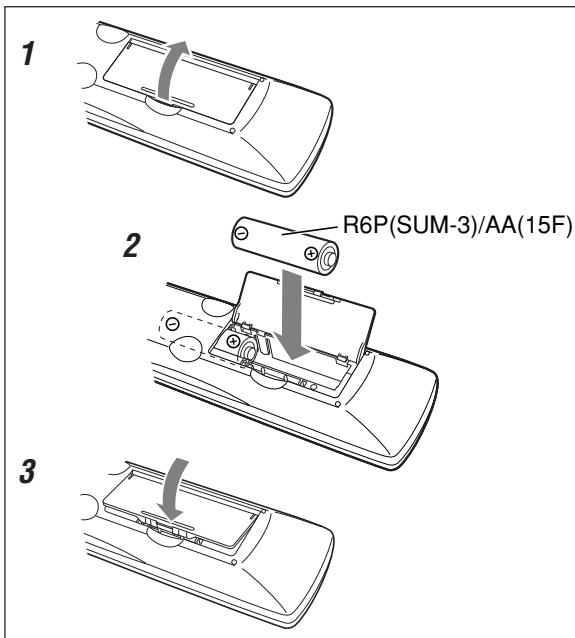

- DO NOT use an old battery together with a new one.
- DO NOT use different types of batteries together.
- DO NOT expose batteries to heat or flame.
- DO NOT leave the batteries in the battery compartment when you are not going to use the remote control for an extended period of time. Otherwise, the remote control will be damaged from battery leakage.

## Connecting Antennas

### FM antenna

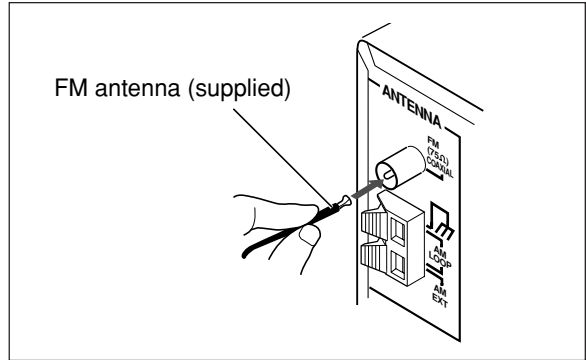

- 1 Attach the FM antenna to the FM (75 Ω) COAXIAL terminal.
- 2 Extend the FM antenna.
- 3 Fasten it up in the position which gives you the best reception.



#### About the supplied FM antenna

The FM antenna supplied with this unit can be used as temporary measure. If reception is poor, you can connect an outdoor FM antenna.

#### To connect an outdoor FM antenna

Before connecting it, disconnect the supplied FM antenna.

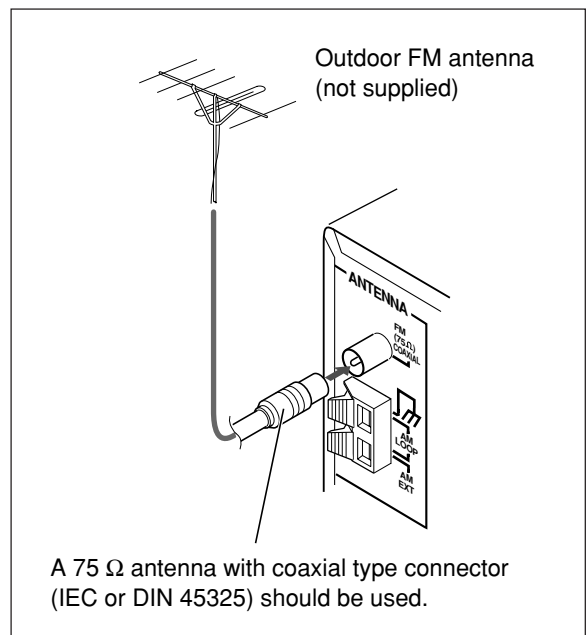

## AM antenna

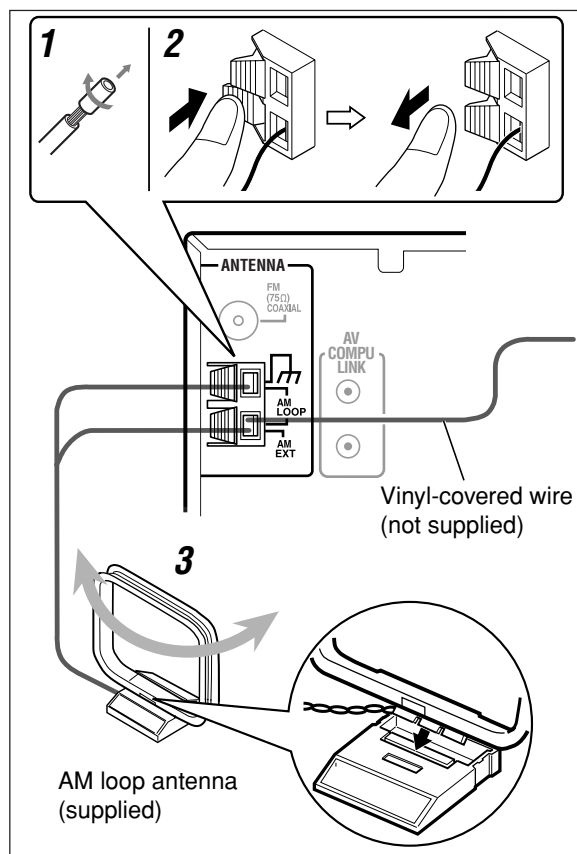

- 1 If the cords are covered with insulation, remove the short section of insulation at the end of each cord by twisting and pulling it off.
- 2 Connect the AM loop antenna to the AM LOOP terminals as illustrated.
- 3 Turn the AM loop antenna until you have the best reception.

### To connect an outdoor AM antenna

When reception is poor, connect a single vinyl-covered wire to the AM EXT terminal and extend it horizontally. The AM loop antenna must remain connected.



**For better reception of both FM and AM**

- Make sure the antenna conductors do not touch any other terminals or connecting cords.
- Keep the antennas away from metallic parts of the unit, connecting cords, and the AC power cord.

## Connecting Speakers

### To connect speakers

You can connect the speakers using the speaker cords.

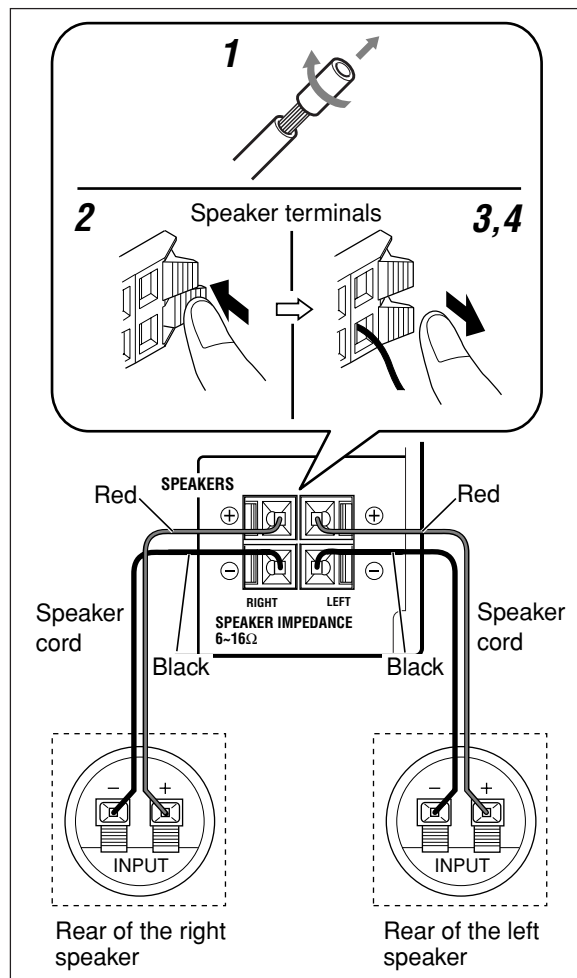

- 1 If the cords are covered with insulation, remove the short section of insulation at the end of each cord by twisting and pulling it off.
- 2 Hold the clamp of the speaker terminal.
- 3 Insert the end of the speaker cord into the terminal. Match the polarity of the speaker terminals: (+) to (+) and (-) to (-).
- 4 Release your finger from the clamp.

### IMPORTANT:

- Use only speakers with the same speaker impedance as indicated by the speaker terminals on the rear of the unit.
- DO NOT connect more than one speaker to one speaker terminal.

## To remove the speaker grilles

The speaker grilles are removable as illustrated below:

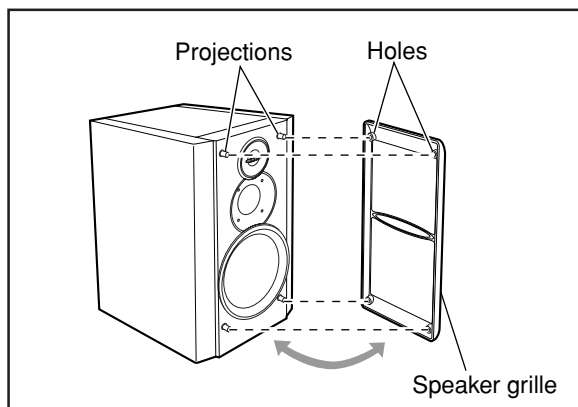

**To remove the speaker grille**, insert your fingers at the top of the speaker grille, then pull towards you. Also pull the bottom towards you.

**To attach the speaker grille**, follow the illustration above.

### Caution on installation

This unit is compact but high powered, so it has a built-in cooling fan which operates when the internal heat rises due to continuous use and/or high volume level. If you want to place speakers or any equipment on the sides of the unit, leave a space of at least 1 cm between the main unit and each other unit to obtain sufficient cooling effect.

## Connecting a TV

Connect your TV and this unit using the composite video cord (supplied) or an S-video cord (not supplied).

- DVDs are protected by the copyguard system. Connecting to a TV through a VCR (or to a TV with a built-in VCR) may cause distortion of picture.
- You can also use JVC's AV COMPU LINK control system. (See page 65.)

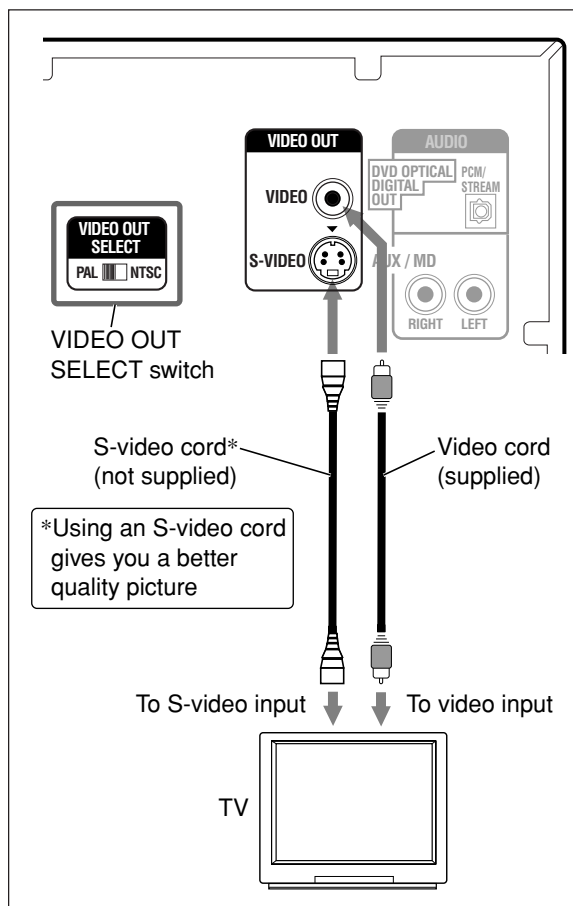

### To select the color system

This unit is compatible with the PAL and NTSC systems. Set the VIDEO OUT SELECT switch on the rear panel while in standby mode to match the color system of your TV. Make sure that the color system marked on the package of a DVD, SVCD, or VCD matches that of your TV.



**Before playing back a disc**, select the correct "MONITOR TYPE" in the DISPLAY menu according to the aspect ratio of your TV. See "To select the monitor type" on page 15.

## Connecting Other Equipment

You can connect other equipment such as a digital decoder to reproduce multichannel sounds or audio equipment which can be used as a playback device.

When you connect and use such equipment, refer also to its manual.



- DO NOT connect other equipment while the power is on.
- DO NOT plug in any equipment until all connections are complete.

### To connect audio equipment with an optical digital input terminal—such as a digital decoder

By using an optical digital cord (not supplied), you can connect audio equipment with an optical digital input terminal.

To reproduce multichannel sounds such as Dolby Digital 5.1 ch, DTS Digital Surround or MPEG Multichannel, connect a digital decoder or an amplifier with a built-in decoder.

- See “About sounds output through the DVD OPTICAL DIGITAL OUT terminal” on the right column.

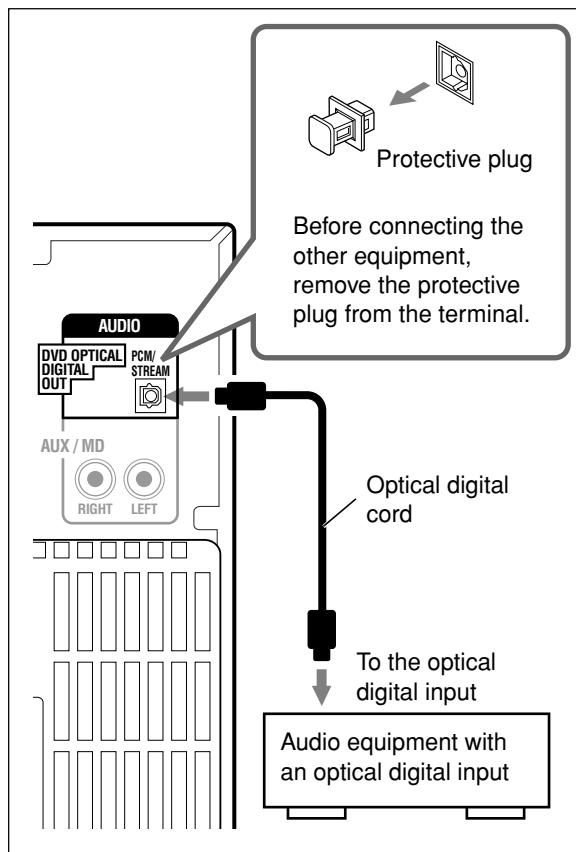

Before playing back a disc, select “DIGITAL AUDIO OUTPUT” in the AUDIO menu according to audio equipment connected to the DVD OPTICAL DIGITAL OUT terminal. See “To select the output signal type” on page 16.

### About sounds output through the DVD OPTICAL DIGITAL OUT terminal

Digital signals (Linear PCM, Dolby Digital\*, DTS\*\*, MPEG Multichannel) are output from the disc played back on the built-in DVD player.

To reproduce multichannel sounds such as Dolby Digital 5.1 ch, DTS Digital Surround and MPEG Multichannel, connect an amplifier or a decoder compatible with these multichannel sources to this terminal.

- \* Manufactured under license from Dolby Laboratories. “Dolby” and the double-D symbol are trademarks of Dolby Laboratories. Confidential unpublished works. © 1992–1997 Dolby Laboratories. All rights reserved.
- \*\* Manufactured under license from Digital Theater Systems, Inc. US Pat. No. 5,451,942 and other world-wide patents issued and pending. “DTS,” and “DTS Digital Surround” are trademarks of Digital Theater Systems, Inc. Copyright 1996, 2000 Digital Theater Systems, Inc. All Rights Reserved.

## To connect analog audio equipment

By using an RCA pin plug cord (not supplied), you can connect equipment with analog audio output jacks such as an MD player, a TV, etc.

- Be sure that the plugs of the audio cords and the jacks on the rear of the unit are color-coded:  
White plugs and jacks are for left audio signals, and red ones for right audio signals.

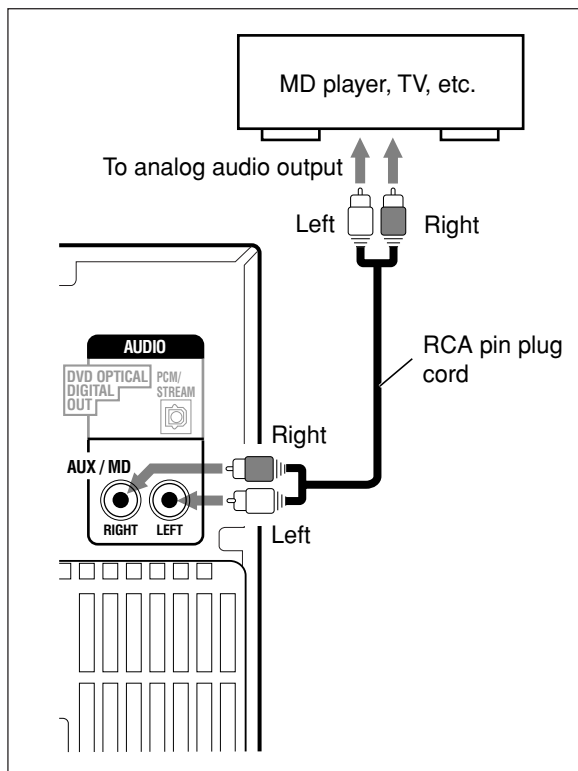

To listen to or to record the sound from analog audio equipment connected to the AUX/MD jacks, select “AUX/MD” as the source to play. (See page 20.)

**NOW you are ready to plug in the unit and any other connected equipment.**

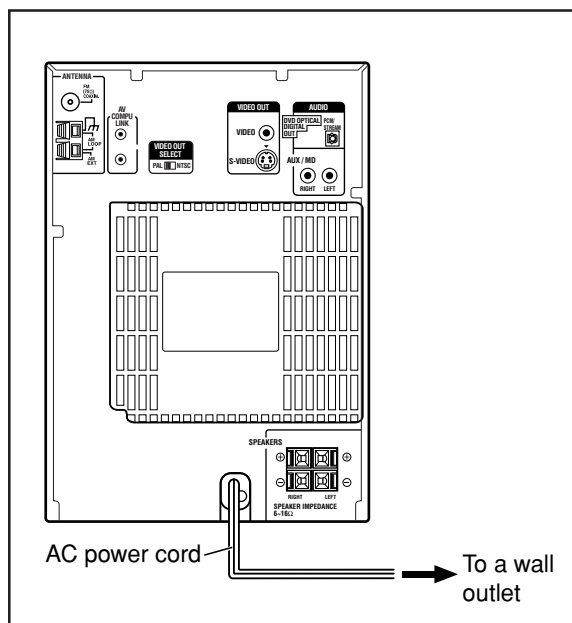

When you connect the AC power cord into a wall outlet, the unit automatically starts the display demonstration (Automatic display demonstration).

- Each time you press and hold COLOR/DEMO (or COLOR on the remote control) for more than 2 seconds, the Automatic display demonstration turns on (“DEMO ON” appears in the main display) and off (“DEMO OFF” appears in the main display).

**To stop and cancel the display demonstration manually,** press COLOR/DEMO (or COLOR on the remote control) during display demonstration while the unit is in standby mode.

- Pressing DIMMER (see page 22) or DISPLAY (see page 17) also cancels the display demonstration.
- “0:00” flashes in the main display until you set the built-in clock. After setting the clock, the clock time will appear in the main display while the unit is turned off. To set the built-in clock, see “Setting the Clock” on page 17.

**To start the display demonstration manually,** press COLOR/DEMO (or COLOR on the remote control) while the unit is in standby mode.

- Each time you press the button, the display demonstration alternates between on and off.

## Setting the DVD Player

You need to set the following, using the setting menu shown on the TV, before starting playback.

- You can select the language used in the setting menu.
- If an Audio CD or MP3 disc is loaded, you cannot show the setting menu. Before starting the setting, remove the disc.
- For further information about the setting menu, see pages 55 to 59.

**Step 1:** Selecting the On-screen language for the setting menu

**Step 2:** Selecting the monitor type according to your TV

If audio equipment is connected to the DVD OPTICAL DIGITAL OUT terminal:

**Step 3:** Selecting the output signal type

If audio equipment is NOT connected to the DVD OPTICAL DIGITAL OUT terminal:  
**Setting is finished.**



**notes** If no operation is done for about five minutes while the setting menu appears on the TV

The screen saver screen (see page 28) automatically appears on the TV instead of the setting menu to prevent the TV screen from being damaged.

To show the setting menu again, press CHOICE while holding down SHIFT.

### On the remote control ONLY:

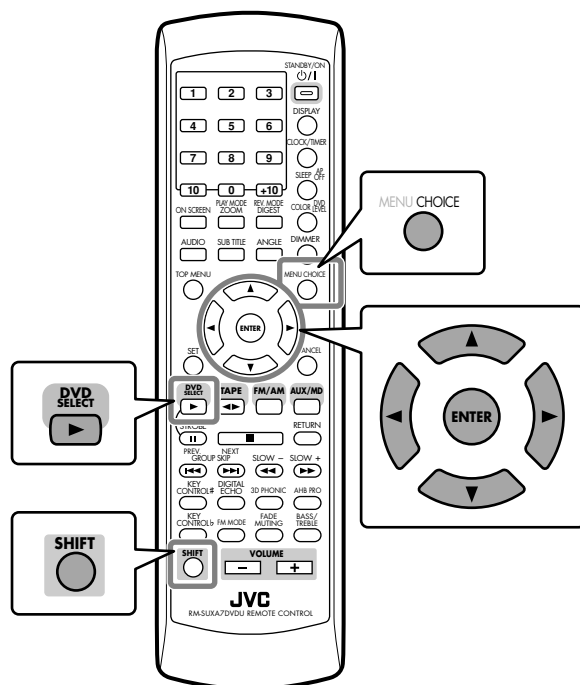

### To select the On-screen language for the setting menu—Step 1:

- 1** Turn on the TV and select the correct input mode on the TV.
- 2** Press **DVD SELECT** ►, then **■**.  
The unit turns on and the DVD player is selected as the source to play.  
The opening screen appears on the TV.

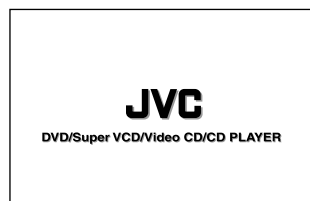



### 3 Press CHOICE while holding down SHIFT.

The 语言 (LANGUAGE) menu appears on the TV.

- When you purchased this unit, the On-screen language used for the setting menu is set to Chinese (中国语).
- A selected item shows in green.

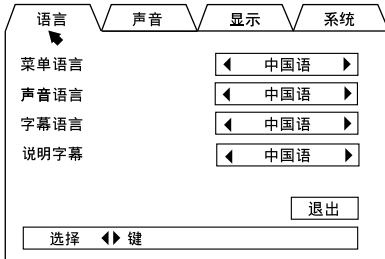

Go to “To select the monitor type” on the next page. ➡

### 4 Press Cursor ▼ repeatedly to move ◀ to “说明字幕” (ON SCREEN LANGUAGE).

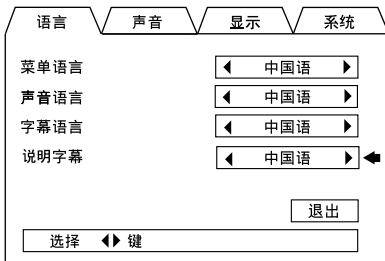

### 5 Press Cursor ▶/◀ to select the language you want.

You can select the language from among ENGLISH, Chinese (中国语), and Spanish (ESPAÑOL).

The language for the setting menu changes to the one you select.

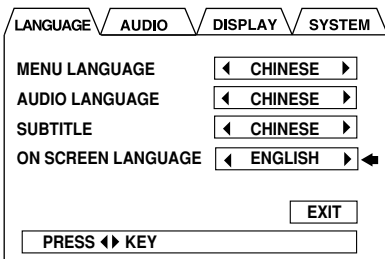

Ex.: “ENGLISH” is selected.

- The language in other indications shown on the TV while you operate the unit also changes to the one you select.

## To select the monitor type—Step 2:

You need to select the monitor type to match your TV to play back DVDs recorded with a height/width ratio of 16:9.

- 1** Press Cursor **▲** repeatedly to move **▶** to “LANGUAGE.”

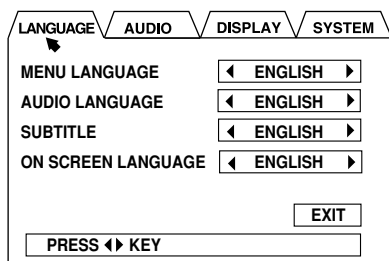

- 2** Press Cursor **▶/◀** repeatedly to move **▶** to “DISPLAY.”

The DISPLAY menu appears on the TV.

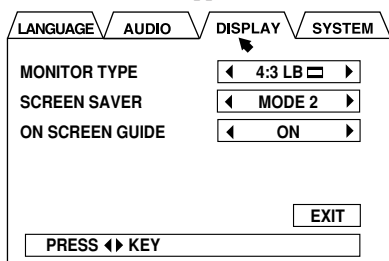

- 3** Press Cursor **▼** to move **◀** to “MONITOR TYPE.”

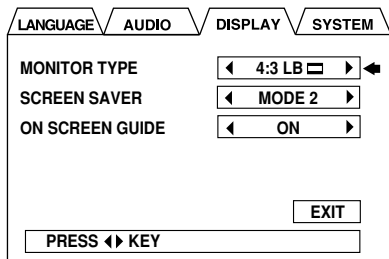

- 4** Press Cursor **▶/◀** to select the monitor type.

Select the monitor type according to the guidelines on the right column.

- If audio equipment is connected to the DVD OPTICAL DIGITAL OUT terminal:  
**Go to “To select the output signal type” on the next page. ▶▶**
- If audio equipment is NOT connected to the DVD OPTICAL DIGITAL OUT terminal:  
**The setting is done.**  
**Press CHOICE while holding down SHIFT.**  
The setting menu goes off.

## ■ Guidelines to select the monitor type

Selectable types: 4:3 LB , 16:9 WIDE, 4:3 PS

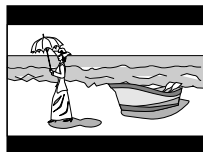

- **4:3 LB (Letter Box)** :  
Select when viewing on a TV whose aspect ratio is 4:3.  
While viewing a wide screen picture, the black bars appear on the top and the bottom of the screen.

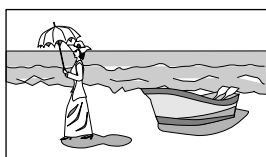

- **16:9 WIDE:**  
Select when viewing on a TV whose aspect ratio is 16:9.

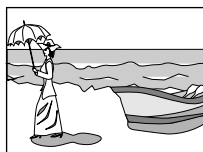

- **4:3 PS (Pan Scan)** :  
Select when viewing on a TV whose aspect ratio is 4:3.  
While viewing a wide screen picture, the black bars do not appear; however, a portion of the left and right edges of the picture will not show on the screen.

- Even if “4:3 PS ” is selected, the screen size may become “4:3 LB ” while playing some DVDs. This depends on how the DVD is programmed and recorded.
- If a disc (or some portions of the disc) is recorded with video signals of 4:3 aspect ratio, this setting does not take effect. The pictures are displayed with full 4:3 aspect ratio or with 4:3 Letter Box.

### To select the output signal type—Step 3:

If you connect audio equipment to the DVD OPTICAL DIGITAL OUT terminal, you need to select the type of digital signals output through the terminal according to the particular kind of audio equipment.

**1** Press Cursor **▲** to move **▶** to “DISPLAY.”

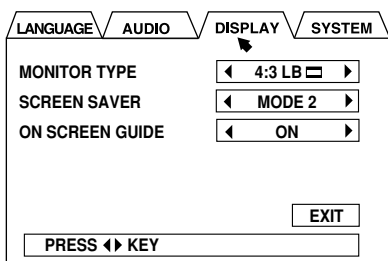

**2** Press Cursor **◀** to move **▶** to “AUDIO.”  
The AUDIO menu appears on the TV.

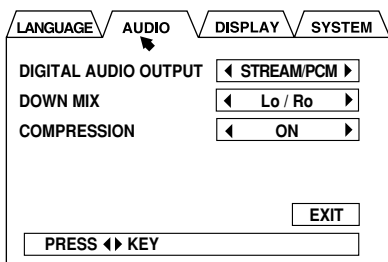

**3** Press Cursor **▼** to move **◀** to “DIGITAL AUDIO OUTPUT.”

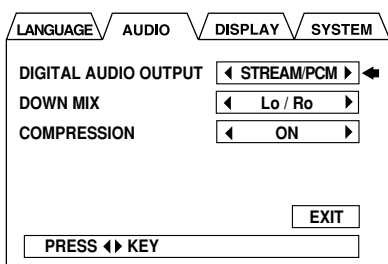

**4** Press Cursor **▶/◀** to select the output signal type.  
Select the output signal type according to the guidelines on the right column.

### ■ Guidelines to select the output signal type

Selectable types: STREAM/PCM, PCM ONLY, DOLBY DIGITAL/PCM

#### • STREAM/PCM:

Select when connecting an amplifier or a decoder compatible with DTS, Dolby Digital and MPEG Multichannel.

#### • PCM ONLY:

Select when connecting an amplifier compatible only with Linear PCM or a digital recording device such as an MD recorder, DAT deck, etc.

#### • DOLBY DIGITAL/PCM:

Select when connecting an amplifier or a decoder compatible only with Dolby Digital.

### Output Signals Through the DVD OPTICAL DIGITAL OUT Terminal

Playback disc	Output signals		
	STREAM/PCM	PCM ONLY	DOLBY DIGITAL/PCM
DVD with 48 kHz, 16 bit Linear PCM	48 kHz, 16 bit Linear PCM	◀	◀
DVD with 48 kHz, 20/24 bit Linear PCM	48 kHz, 20/24 bit Linear PCM	◀	◀
DVD with 96 kHz, Linear PCM	No output	◀	◀
DVD with Dolby Digital	Dolby Digital bitstream	48 kHz, 16 bit Linear PCM	Dolby Digital bitstream
DVD with DTS	DTS bitstream	No output	◀
DVD with MPEG Multichannel	MPEG bitstream	48 kHz, 16 bit Linear PCM	◀
SVCD/VCD/Audio CD	44.1 kHz, 16 bit Linear PCM	◀	◀
Audio CD with DTS Digital Surround	DTS bitstream	◀	◀
MP3 disc	No output	◀	◀



**When “PCM ONLY” or “DOLBY DIGITAL/PCM” is selected as the output signal type**

The sound signals of DTS are not output from the DVD OPTICAL DIGITAL OUT terminal.

To listen to the sound of DTS on audio equipment connected to the terminal, select “STREAM/PCM” as the output signal type.



**When “PCM ONLY” is selected as the output signal type**

Also set “DOWN MIX” in the AUDIO menu. (See page 57.)

**To exit from the setting menu**, press CHOICE while holding down SHIFT.

The setting menu goes off.

- You can also exit from the setting menu by pressing Cursor **▲/▼** to select EXIT in the menu, then press ENTER.

## Setting the Clock

You can set the clock when the unit is either turned on or in standby mode.

### On the remote control ONLY:

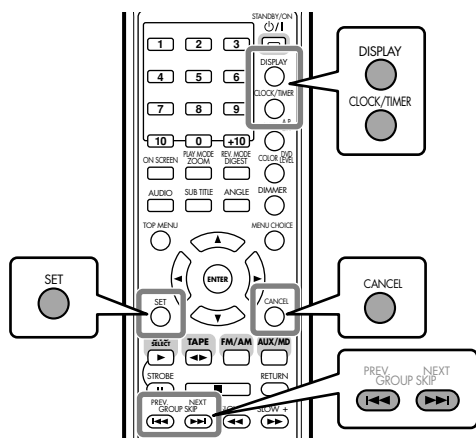

### 1 Press **CLOCK/TIMER**.

“0:00” appears in the main display with the hour digit flashing.

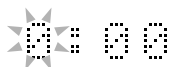

### 2 Press **▶▶** or **◀◀** repeatedly to adjust the hour.

- When you press and hold the button, the hour digit changes continuously.
- You can also use the number buttons.
  - To adjust the hour to 5, press 5.
  - To adjust the hour to 12, press +10, then 2.
  - To adjust the hour to 20, press +10, then 10 (or press +10 twice, then 0).

### 3 Press **SET** to set the hour.

The minute digit starts flashing.

- If you want to change the hour again, press **CANCEL**.  
The hour digit starts flashing again.

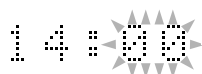

### 4 Press **▶▶** or **◀◀** repeatedly to adjust the minute.

- When you press and hold the button, the minute digit changes continuously.
- You can also use the number buttons.
  - To adjust the minute to 5, press 5.
  - To adjust the minute to 25, press +10, +10, then 5.
  - To adjust the minute to 30, press +10, +10, then 10 (or press +10 three times, then 0).

### 5 Press **SET** to finish setting the clock.

The built-in clock starts.



#### To adjust the clock again

Once you have adjusted the clock, you need to press **CLOCK/TIMER** repeatedly until the clock setting screen appears in the main display (the hour digit starts flashing).



#### When you unplug the AC power cord or if a power failure occurs

The clock loses its setting and resets to “0:00.” If this happens, set the clock again.

### To turn off the clock indication (power save mode)

#### On the remote control ONLY:

Press **DISPLAY** while the unit is in standby mode.

“DISPLAY OFF” appears in the main display and the clock indication goes off.

To turn on the clock indication, press **DISPLAY** again while the unit is in standby mode.

“DISPLAY ON” appears in the main display.

### To show the clock when the unit is turned on

#### On the remote control ONLY:

Press **DISPLAY**.

The clock indication appears in the main display.

To return to the normal display, press **DISPLAY** again.

# Basic and Common Operations

The buttons emphasized in the illustration below are used and explained in the following section (pages 19 to 23).

## Remote control

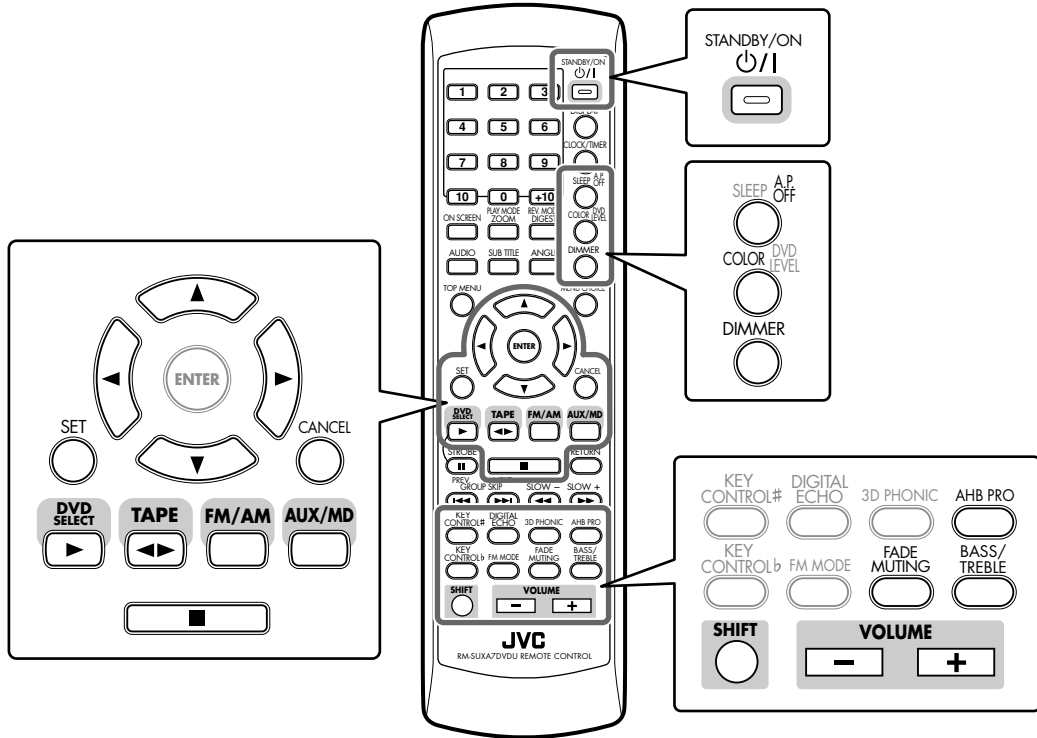

## Main unit

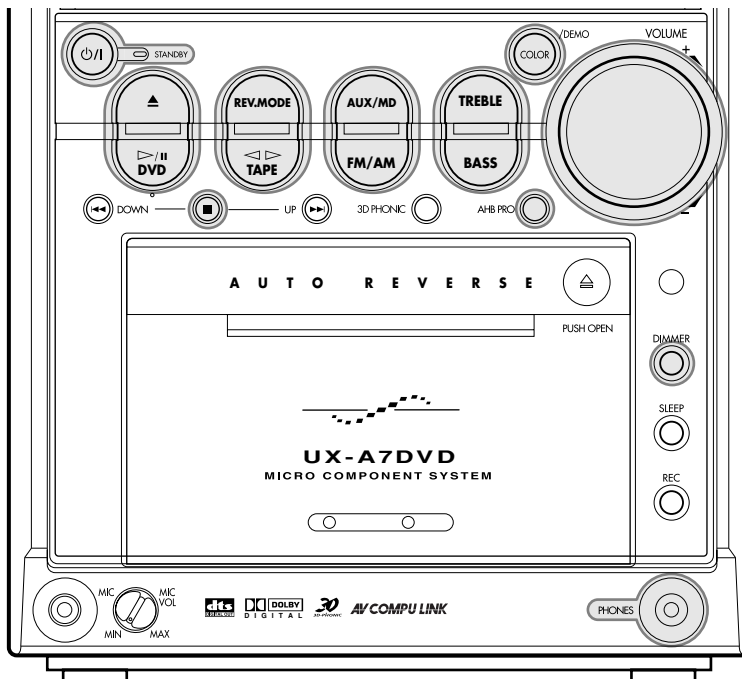

## Turning On the Power

When you press one of the source selecting buttons, the unit automatically turns on (and starts playback if the source is ready).

### On the remote control:

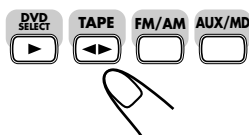

### On the main unit:

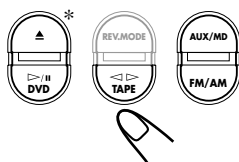

\* Pressing DVD ▲ also turns on the unit.

**To turn on the unit without playing,** press STANDBY/ON  $\odot$ /I (or  $\odot$ /I on the main unit). The STANDBY lamp on the main unit goes off. “HELLO” appears in the main display.

**To turn off the unit (on standby),** press STANDBY/ON  $\odot$ /I (or  $\odot$ /I on the main unit) again. The STANDBY lamp on the main unit lights up. “SEE YOU” appears in the main display.

- When you use the Resume function (see page 58), turning off the power while playing a disc stops playback and stores the stop point. By pressing DVD SELECT  $\blacktriangleright$  (or DVD  $\triangleright$ /II on the main unit), you can turn on the unit and start playback again from the position where you have stopped—Resume play. (“RESUME” appears in the main display.)
- A little power is always consumed even while the unit is in standby mode.

**To switch off the power supply completely,** unplug the AC power cord from the AC outlet.



**When you unplug the AC power cord or if a power failure occurs**

The settings you have done will be erased.

### To turn off the unit automatically (Auto Power Off)

Using the Auto Power Off function, the unit automatically turns itself off if no sound comes in for more than 3 minutes when the DVD player or “TAPE” is selected as the source.

If an operation is done during this 3-minute period, Auto Power Off is canceled temporarily even though no sound comes in.

- You can also turn off the unit automatically by using the sleep timer. (See page 64.)

### On the remote control ONLY:

**To activate Auto Power Off,** press A.P.OFF while holding down SHIFT.

The A.P.off (Auto Power off) indicator lights up on the display.

- When no sound comes in, the A.P.off indicator starts flashing on the display. About 20 seconds before the unit turns itself off, “AUTO POWER OFF” starts flashing in the main display.

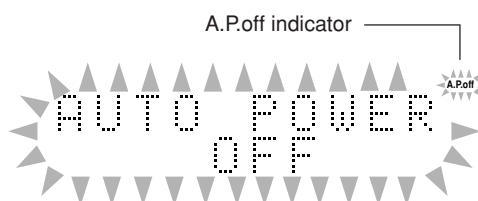

**To deactivate Auto Power Off,** press A.P.OFF while holding down SHIFT.

The A.P.off indicator goes off.

## Selecting the Sources and Starting Play

**To select the tuner as the source,** press FM/AM. The unit automatically turns on (when the unit is in standby), and the last selected band appears in the main display.

- Each time you press the button, the band alternates between FM and AM.

• For more detailed operations, see pages 24 to 26.

**To select the DVD player as the source,** press DVD SELECT ► (or DVD ▷/■ on the main unit). The unit automatically turns on (when the unit is in standby), and “READING” appears in the main display for a while.

- Play will start if a disc is in the disc tray.
- “NO DISC” will appear in the main display if a disc is not loaded.

To stop playback, press ■.

• For more detailed operations, see pages 27 to 39, 42 to 48.

**To select the tape as the source,** press TAPE ◀▶.

The unit automatically turns on (when the unit is in standby), and “TAPE” appears in the main display.

- Play will start if a tape is in the cassette holder.

To stop playback, press ■.

• For more detailed operations, see pages 40 and 41.

**To listen to the sound from external equipment,** press AUX/MD.

The unit automatically turns on (when the unit is in standby), and “AUX/MD” appears in the main display.

• For operating external equipment, see its manual also.



### When changing from another source to “AUX/MD”

If the sound from the component connected to the AUX/MD jacks is too loud or is not loud enough (without changing the volume level), you can change the audio input level through the AUX/MD jacks. (See page 23.)

## Adjusting the Volume

You can adjust the volume level only while the unit is turned on.

- The volume level has no effect on recording.

### On the remote control:

**To increase the volume,** press VOLUME +.

**To decrease the volume,** press VOLUME –.

- When you press and hold each button, you can change the volume level continuously.

### On the main unit:

**To increase the volume,** turn VOLUME + / – control clockwise.

**To decrease the volume,** turn VOLUME + / – control counterclockwise.

VOLUME 21

- You can adjust the volume level within the range of 0 (silent) to 40 (maximum).



### For private listening

Connect a pair of headphones to the PHONES jack. No sound comes out of the speakers. Be sure to turn down the volume before connecting or putting on the headphones.



DO NOT turn off (on standby) the unit with the volume set to an extremely high level; Otherwise, the sudden blast of sound can damage your hearing, speakers and/or headphones when you turn on the unit or start playing any source.  
REMEMBER you cannot adjust the volume level while the unit is in standby mode.

## To turn down the volume level temporarily

### On the remote control ONLY:

Press FADE MUTING.

The volume level gradually decreases to “VOLUME 0.”

**To restore the sound,** press FADE MUTING again.

- Turning VOLUME + / – control clockwise (to +) on the unit or pressing VOLUME + on the remote control also restores the sound.

## Reinforcing the Bass Sound

The richness and fullness of the bass sound is clearly maintained regardless of how low you set the volume —Active Hyper Bass Pro.

- This function also affects the sound from headphones.
- This function affect neither recording nor the signals output through the DVD OPTICAL DIGITAL OUT terminal.

**To get the effect**, press AHB PRO repeatedly so that “AHB PRO 1” or “AHB PRO 2” appears in the main display. The AHB PRO indicator also lights up on the display.

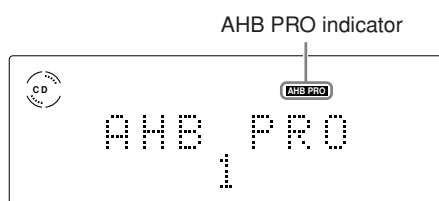

Ex.: When you select “AHB PRO 1.”

- Each time you press the button, the Active Hyper Bass Pro mode changes as follows:

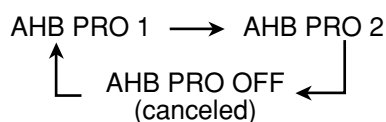

- “AHB PRO 2” is more effective than “AHB PRO 1.”

**To cancel the effect**, press AHB PRO repeatedly until “AHB PRO OFF” appears in the main display. The AHB PRO indicator goes off.

## Adjusting the Tone

You can adjust the bass and treble sounds as you like.

- This function also affects the sound from headphones.
- This function affect neither recording nor the signals output through the DVD OPTICAL DIGITAL OUT terminal.
- There is a time limit in doing the following steps. If the setting is canceled before you finish, start from step **1** again.

### On the remote control:

#### 1 Press BASS/TREBLE.

- Each time you press the button, “BASS” and “TREBLE” appears in the main display alternately.
- BASS:** Select when you adjust the bass level.  
**TREBLE:** Select when you adjust the treble level.



Ex.: When you select “BASS.”

#### 2 Press VOLUME + / - to adjust the tone level.

You can adjust the tone level within the range from “-1” to “+5” by 1 step. (“0” is the initial setting.)

- To increase the tone level**, press VOLUME +.  
**To decrease the tone level**, press VOLUME -.

When selecting other levels than “0,” the TONE indicator lights up.

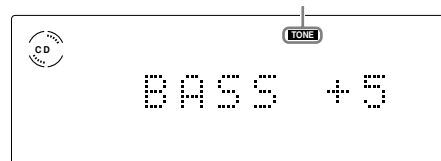

### On the main unit:

#### 1 Press BASS or TREBLE.

- Press BASS when you adjust the bass level.
- Press TREBLE when you adjust the treble level.

#### 2 Turn VOLUME + / - control to adjust the tone level.

You can adjust the tone level within the range from “-1” to “+5” by 1 step. (“0” is the initial setting.)

**To increase the tone level**, turn VOLUME + / - control clockwise.

**To decrease the tone level**, turn VOLUME + / - control counterclockwise.



## Changing the Display Illumination

You can change the illumination color and brightness of the electronic swing panel and the display window.

### To select the illumination color

You can set the illumination color to your preference.

Press **COLOR** (or **COLOR/DEMO** on the main unit) repeatedly while the unit is turned on until the color you want appears in the main display.

- Each time you press the button, the illumination color changes as follows:

<b>RAINBOW:</b>	The rainbow colors illuminate the electronic swing panel and the display.
↓	
<b>GRADATION:</b>	The illumination color changes gradually.
↓	
<b>WATER:</b>	A blue-based illumination pattern.
↓	
<b>FANTASY:</b>	Pastel colors illuminate the electronic swing panel and the display.
↓	
<b>CANDLE:</b>	A red-based illumination pattern.
↓	
<b>FOREST:</b>	A green-based illumination pattern.
↓	
<b>SNOW:</b>	A white-based illumination pattern.
↓	
<b>SKY:</b>	A sky-color based illumination pattern. The color changes according to the time if the built-in clock is set. If not, "ADJUST! CLOCK" flashes in the main display when you select this illumination color.
↓	
<b>MANUAL1:</b>	You can set the illumination color as you like (see the right column).
↓	
<b>MANUAL2:</b>	
↓	

(back to the beginning)



#### More on the illumination color

- The illumination colors cannot always be reproduced precisely. Due to the circumstances (room temperature, etc.) where the unit is used or the setting of DIMMER, colors may vary slightly.
- When you change the illumination color, the display may seem to move back and forth; this is a characteristic of this unit and is not a malfunction.
- When a strong light strikes the unit, it may become dark, but this is not a malfunction.
- While using the unit, the electronic swing panel becomes warm, but this is not a malfunction.

### To create your favorite colors

You can create two favorite colors and store them in memory as "MANUAL1" and "MANUAL2."

- There is a time limit in doing the following steps. If the unit exits from the color adjusting mode before you finish, start from step 1 again.

#### On the remote control ONLY:

- Press **COLOR** repeatedly until "MANUAL1" or "MANUAL2" appears in the main display.  
The brightness level to be adjusted starts flashing.

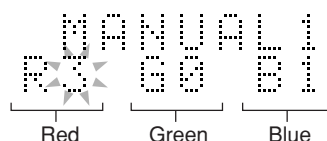

- To adjust the brightness of each color
  - Press **Cursor** ▶/◀ to select one of the fundamental colors (Red, Green, Blue) you want to adjust.
  - Press **Cursor** ▲/▼ repeatedly to adjust the level of the brightness (within the range of 0 to 3).
    - As you increase the number, the color becomes brighter.
    - To restore the initial color for "MANUAL1" or "MANUAL2," press **CANCEL**.
  - Repeat steps 1) and 2) to create your favorite color.
  - Press **SET**.  
Your favorite color is stored.



If you do not make any adjustment for about 8 seconds

The normal display resumes and the color you have created up to that time is stored.

### To change the display brightness

Press **DIMMER** while the unit is turned on.

- Each time you press the button, the display brightness changes as follows:

**DIMMER 1:** The display illumination dims.



**DIMMER 2:** The illumination color disappears.



**DIMMER OFF:** The display illumination resumes.

- Pressing **COLOR** (or **COLOR/DEMO** on the main unit) also resumes the display brightness.



(back to the beginning)

## Adjusting the Audio Input Level

If the sound from the component connected to this unit is too loud or is not loud enough when changing from another source to “AUX/MD” (without changing the volume level), you can change the audio input level through the AUX/MD jacks.

**1** Press AUX/MD so that “AUX/MD” appears in the main display.

**2** Press and hold SET on the remote control for more than 2 seconds.

- Each time you press and hold the button, the audio input level alternates between “LEVEL 1” and “LEVEL 2.”

**LEVEL 1:** Select when the sound is too loud (initial setting).

**LEVEL 2:** Select when the sound is not loud enough.

AUX/MD  
LEVEL 1



**notes** If you change the audio input level through the AUX/MD jacks

The recording level through the AUX/MD jacks also changes. Selecting “LEVEL 2” rather than “LEVEL 1” makes the sound recorded louder.

## Prohibiting Disc Ejection

You can prohibit disc ejection from the unit and can lock discs—Disc Lock.

### On the main unit ONLY:

**To prohibit disc ejection,** press and hold ■, then press REV. MODE when the unit is in standby mode.

“LOCKED” appears in the main display for a while, and the loaded disc is locked.

LOCKED

If you try to eject the locked disc, “LOCKED” appears to inform you that the Disc Lock is in use.

**To cancel the prohibition and unlock the disc,** repeat the above procedure.

“UNLOCKED” appears in the main display for a while, and the loaded disc is unlocked.

# Listening to FM and AM Broadcasts

The buttons emphasized in the illustration below are used and explained in the following section (pages 25 and 26).

## Remote control

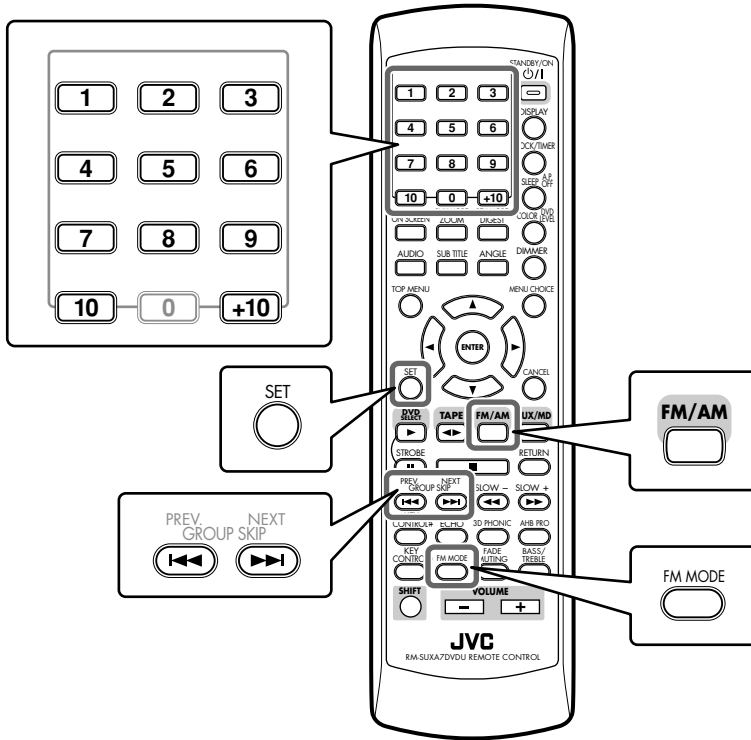

## Main unit

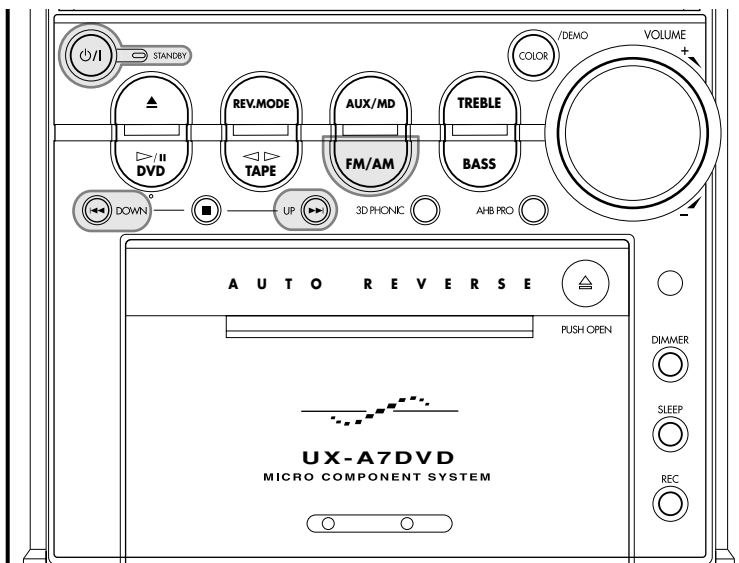

## Setting the AM Tuner Interval Spacing

Some countries space AM stations 9 kHz apart, and some countries use 10 kHz spacing.

When shipped, the built-in AM tuner is set to 9 kHz spacing. You can change it to 9 kHz or 10 kHz spacing.

### **On the main unit ONLY:**

**To set the AM tuner to the 10 kHz spacing**, be sure that the unit is turned off, but is plugged into a wall outlet.

While holding ►►, press ⏻/|. The unit turns on and tunes in to 530 kHz.

**To set it back to the 9 kHz spacing**, be sure that the unit is turned off, but is plugged into a wall outlet.

While holding ◀◀, press ⏻/|. The unit turns on and tunes in to 531 kHz.



### **When you change the AM tuner interval spacing**

The preset stations you have set (both FM and AM) will be erased. In this case, preset stations again. See “Presetting Stations” on the next page.

## To change the FM reception mode

When an FM stereo broadcast is noisy or hard to receive, you can change the FM reception mode to improve the reception.

### **On the remote control ONLY:**

#### **Press FM MODE.**

- Each time you press the button, FM reception mode alternates between STEREO and MONO.

**STEREO:** Normally select this.

You can hear stereo sound when a program is broadcast in stereo. The STEREO indicator lights while receiving the FM stereo broadcast (only when the reception is good).

**MONO:** Select this when an FM stereo broadcast is noisy or hard to receive. Reception improves though stereo effect is lost. The MONO indicator lights up on the display.

## Tuning in to a Station

### **1 Press FM/AM to select either “FM” or “AM.”**

When you press the button for the first time, the unit automatically turns on with the last selected band.

- Each time you press the button, the band alternates between FM and AM.

### **2 Press and hold ►► or ◀◀ (or UP or DOWN on the main unit) until the station frequencies start changing continuously in the main display.**

- ►► (UP): Increases the frequencies.
- ◀◀ (DOWN): Decreases the frequencies.

The unit starts searching for stations and stops when a station of sufficient signal strength is tuned in.

- If an FM program is broadcast in stereo, the STEREO indicator lights up on the display.

**To stop during searching**, press ►► or ◀◀ (or UP or DOWN on the main unit).



### **When you repeatedly press ►► or ◀◀ (or UP or DOWN on the main unit)**

The frequency changes step by step.

## Presetting Stations

You can preset 30 FM and 15 AM stations manually.

In some cases, test frequencies have been already stored for the tuner since the factory examined the tuner preset function before shipment. This is not a malfunction. You can preset the stations you want into memory by following the presetting method.

- There is a time limit in doing the following steps. If the setting is canceled before you finish, start from step **2** again.

### On the remote control ONLY:

#### **1** Tune in to the station (either FM or AM) you want to preset.

- See “Tuning in to a Station” on the previous page.

#### **2** Press SET.

The preset number starts flashing as follows:

FM 87.50 MHz

Ex.: When you select an FM station in step **1**.

- The unit always starts from the preset number 1.

#### **3** Press the number buttons to select a preset number.

Ex.: For preset number 5, press 5.

For preset number 15, press +10, then 5.

For preset number 20, press +10, then 10.

For preset number 30, press +10, +10, then 10.

- You can also select the preset number by pressing **▶▶1** or **1◀◀**.

#### **4** Press SET again.

“STORED” appears in the main display for a while.

STORED

The tuned station in step **1** is stored in the preset number selected in step **3**.

- Storing a new station on an already assigned number erases the previously stored one.



**When you unplug the AC power cord or if a power failure occurs**

The FM and AM preset stations will be erased in a day. If this happens, preset the stations again.

## Tuning in to a Preset Station

### On the remote control ONLY:

#### **1** Press FM/AM to select either “FM” or “AM.”

When you press the button for the first time, the unit automatically turns on with the last selected band.

- Each time you press the button, the band alternates between FM and AM.

#### **2** Press the number buttons to select a preset number.

Ex.: For preset number 5, press 5.





For preset number 15, press +10, then 5.

For preset number 20, press +10, then 10.

For preset number 30, press +10, +10, then 10.

# Playing Back Discs

The buttons emphasized in the illustration below are used and explained in the following section (pages 28 to 39).

     shows the types of discs the operation is available for.

## Remote control

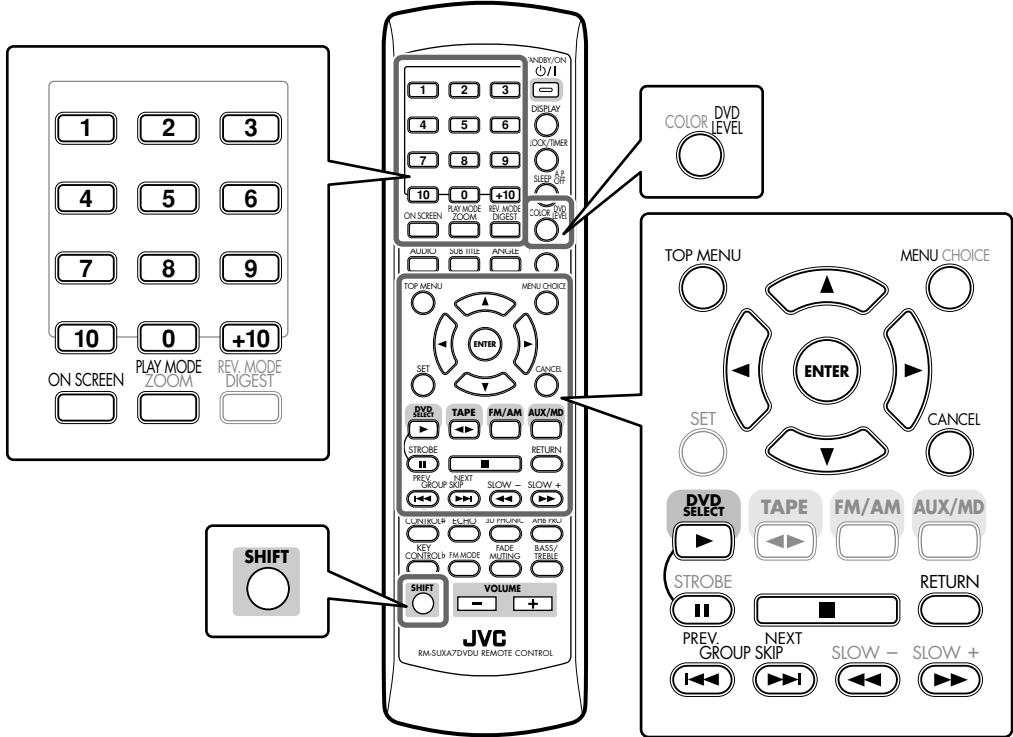

## Main unit

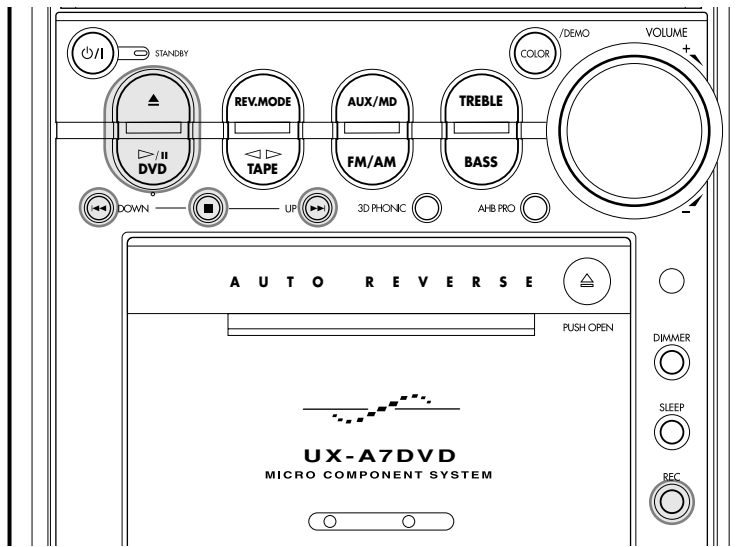

**IMPORTANT:**

Before performing any operations for DVD, SVCD and VCD, make sure of the following:





- Check the connection with the TV.
- Turn on the TV and select the correct input on the TV to view the pictures or on-screen menus/indications on the TV screen.
- Select the correct color system.

**To prevent screen burn-out with the screen saver**

A TV screen may be burned out if a static picture is displayed for a long time. To prevent this, the unit automatically dims the screen if a static picture is displayed for over 5 minutes (the screen saver function).

- Pressing any button will cancel the screen saver function.
- You can select the screen saver mode. (See page 58.)
- The screen saver does not work for Audio CDs and MP3 discs.

**On-screen guide icons**

- During DVD playback, the following guide icons may appear for a while on the TV screen:
  - “”: appears at the beginning of a scene containing multi-angle views.
  - “”: appears at the beginning of a scene containing multi-audio languages.
  - “”: appears at the beginning of a scene containing multi-subtitle languages.
- “▶” (Play), “||” (Pause), “▶▶”/“◀◀” (Fast forward/backward), “|▶”/“◀|” (Slow-motion forward/backward): appears when you perform each operation.
- If “” appears on the TV screen when pressing a button, the disc cannot accept an operation you have tried to do, or information required for that operation is not recorded on the disc.

**More about the on-screen guide icons**

- In some cases, without showing “,” operations will not be accepted.
- If you do not want the on-screen guide icons to appear, see page 58.

**Loading a Disc**

Available for:  DVD  SVCD  VCD  Audio CD  MP3

**1 Press DVD  on the main unit.**

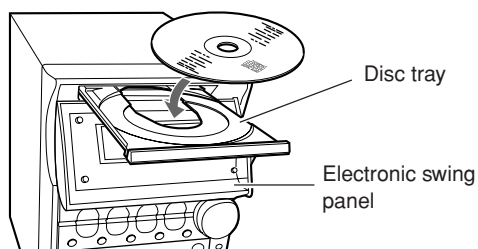
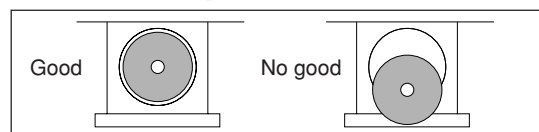

The unit automatically turns on, the electronic swing panel slides downward, then the disc tray comes out.

**2 Place a disc correctly on the circle of the disc tray with its label side up.**



- When using an 8 cm disc, place it on the inner circle of the disc tray.

**3 Press DVD  on the main unit.**

The disc tray closes, then the electronic swing panel slides upward automatically.

- If you press DVD  on the main unit (or DVD SELECT  on the remote control) instead of DVD , the disc tray and electronic swing panel closes, then playback starts.

**To remove the disc, press DVD .**

- After removing the disc, press DVD  again to close the disc tray.
- When you use the Resume function (see page 58), pressing DVD  erases the memory of the position where you have stopped playback.

**About the disc indicators**

When a DVD is loaded.



When a SVCD or VCD is loaded.



When an Audio CD or MP3 disc is loaded.

- The disc indicator rotates while a disc is being played.
- The disc indicator goes off when there is no disc in the disc tray.

## DVD Basic Operations

Available for:  DVD

- To play back a SVCD, VCD, or Audio CD, see page 30.
- To play back an MP3 disc, see page 32.
- Playback will stop when a disc menu appears on the TV screen. **If a menu appears while playing, see “Playing Back by Using the Disc Menu” on page 34.**

### 1 Load a disc.



- With some DVDs, playback starts automatically after you close the disc tray by pressing DVD .

### 2 Press DVD on the main unit (or DVD SELECT on the remote control).

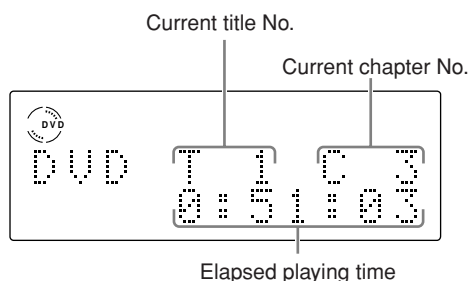

After reading the disc contents, playback starts from the first chapter of the first title.

- The disc playing information appears on the display.





**To stop play for a moment**, press DVD  (or  on the remote control).

While pausing, the elapsed playing time and the disc indicator flash on the display.

- To start playback again, press DVD  again (or press DVD SELECT  on the remote control).

**To stop playing**, press .

- This unit can store the stop point, and when you start playback again by pressing DVD  (or DVD SELECT  on the remote control), playback starts from the position where you have stopped—Resume play. (“RESUME” appears on the display.)



To use Resume play, you need to turn on the Resume function. (See page 58.)

- To stop completely when you use the Resume function, press  twice.

Playback will start from the beginning of the disc.

### To go to another chapter

Press  or  during playback.

- : Goes back to the beginning of the current or previous chapters.
- : Skips to the beginning of the next or succeeding chapters.



Some DVDs may not accept this operation.

### To go to a particular title or chapter directly using the number buttons

#### On the remote control ONLY:

- Pressing the number buttons before playback allows you to start playing with the title number you want.
- Pressing the number buttons during playback allows you to start playing with the chapter number of the currently playing title you want.

Ex.: To select number 5, press 5.

To select number 10, press 10.

To select number 20, press +10, +10 then 0.

To select number 23, press +10, +10 then 3.



**If a menu is shown on the TV while playing a DVD** Number buttons may be used for selecting an item in the menu. (See page 34.)

### To show the on-screen indication

You can show the following information on the TV while playing back a DVD.

#### On the remote control ONLY:

**To show the on-screen indication**, press ON SCREEN while playing a DVD.

- Each time you press the button, the indication on the TV change as follows:

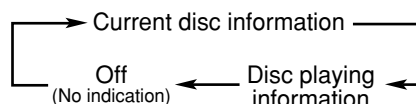



### • Current disc information

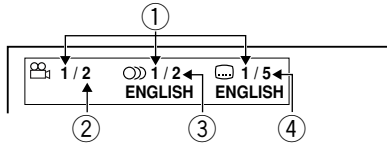

- ① : Current disc information
- ② : Total number of multi-angle views
- ③ : Total number of audio languages
- ④ : Total number of subtitles

### • Disc playing information

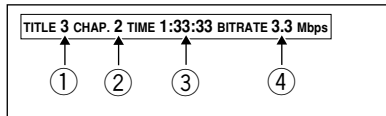

- ① : Current title number
- ② : Current chapter number
- ③ : Elapsed playing time of the current title
- ④ : Transmission rate

### To increase the DVD's sound level

The DVD's audio sound is recorded at a lower level than for other discs such as VCDs or Audio CDs.

If you feel the sound is not strong enough to listen to when playing back a DVD, you can increase the sound level of DVD playback in advance.

- Once you adjust this setting, it is effective every time you play back a DVD.
- This setting does not effect any discs other than DVDs.
- The audio output level through the DVD OPTICAL DIGITAL OUT terminal does not change if you change the DVD sound level.

#### On the remote control ONLY:

To increase the sound level of DVD playback, press DVD LEVEL while holding down SHIFT.

- Each time you press the buttons, the sound level changes as follows:

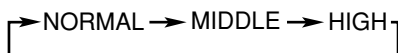

The selected level appears on the display.

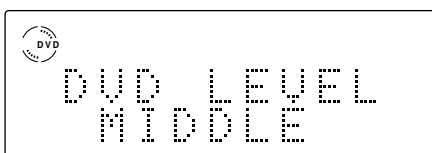

Ex.: When "MIDDLE" is selected.

- When you purchased this unit, the DVD sound level is set to "MIDDLE."

## SVCD/VCD/Audio CD Basic Operations

Available for: SVCD VCD Audio CD

- To play back a DVD, see page 29.
- To play back an MP3 disc, see page 32.
- While playing a SVCD or VCD with the PBC function, the playback will stop when a disc menu appears. **If a menu appears while playing a SVCD or VCD with PBC function, see "Playing Back by Using the Disc Menu" on page 34.**

- 1 Load a disc.
- 2 Press DVD ▷/II on the main unit (or DVD SELECT ► on the remote control).

After reading the disc contents, playback starts from the first track.

- The disc playing information appears on the display.

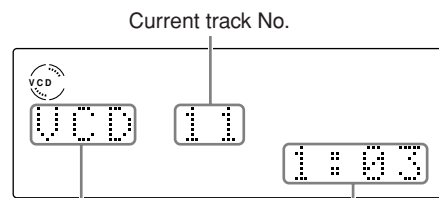

Ex.: When a VCD is played without the PBC function.

- \* About the indication of current disc type
  - "VCD": shows a SVCD or VCD is loaded.
  - "CD": shows an Audio CD is loaded.

- While playing a SVCD or VCD with the PBC function, "PBC" rather than the current track number appears in the main display and the PBC indicator lights up. (About the PBC function, see pages 34 and 35.)

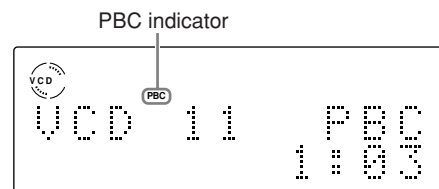

Ex.: When a VCD is played with the PBC function.

**To stop play for a moment**, press DVD ▷/⏸ (or ⏸ on the remote control).

While pausing, the elapsed playing time and the disc indicator flash on the display.

- To start playback again, press DVD ▷/⏸ again (or press DVD SELECT ► on the remote control).

**To stop playing**, press ■.

- This unit can store the stop point, and when you start playback again by pressing DVD ▷/⏸ (or DVD SELECT ► on the remote control), playback starts from the position where you have stopped—Resume play. (“RESUME” appears on the display.)

To use the Resume play, you need to turn on the Resume function. (See page 58.)

–The Resume function does not work for Audio CDs.

–When using Resume play on SVCD or VCD with the PBC function, playback starts a little before the position where you have stopped.

- To stop completely when you use the Resume function, press ■ twice.

## To go to another track

Press ⏮ or ⏭ during playback.

- ⏮: Goes back to the beginning of the current or previous tracks.
- ⏭: Skips to the beginning of the next or succeeding tracks.



**While playing a SVCD or VCD with the PBC function**

The ⏭ and ⏮ buttons may be used for the operations for a disc menu. (See page 34.)

## To go to a particular track directly using the number buttons

**On the remote control ONLY:**

Pressing the number buttons before or during playback allows you to start playing with the track number you want.

Ex.: To select number 5, press 5.

To select number 10, press 10.

To select number 20, press +10, +10 then 0.

To select number 23, press +10, +10 then 3.



**While playing a SVCD or VCD with the PBC function**

If a menu is shown on the TV, number buttons may be used for selecting an item in the menu. (See page 34.)

## To show the on-screen indication

You can show the following information on the TV while playing back a disc.

**On the remote control ONLY:**

**To show the on-screen indication**, press ON SCREEN while playing a disc.

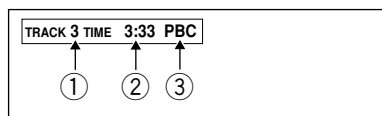

Ex.: When SVCD or VCD with the PBC function is a playing source.

①: Current track number

②: Elapsed playing time of the current track

- ③:
- “PBC” is shown when a SVCD or VCD with the PBC function is played.
  - “EACH” is shown when a SVCD or VCD without the PBC function or an Audio CD is played.

**To erase the on-screen indication**, press ON SCREEN again.

## MP3 Basic Operations

Available for:  MP3

- To play back a DVD, see page 29.
- To play back a SVCD, VCD, or Audio CD, see page 30.

### About MP3 disc

#### What is MP3?

MP3 is an abbreviation of Motion Picture Experts Group 1 (or MPEG-1) Audio Layer 3. MP3 is simply a file format with a data compression. By using MP3 format, one CD-R or CD-RW can contain 10 times as much data volume as a regular CD can.

#### Disc structure

On an MP3 disc, each item (song) is recorded as a track (file), which usually belongs to a group (folder).



This unit can recognize up to 99 groups and up to 254 tracks per group; however, the number of tracks to be played back on a disc is limited to 1023.

If a disc includes more than 1023 tracks, the unit ignores any tracks which have been assigned track numbers exceeding 1023. The unit also ignores any non-MP3 files on the disc.

#### NOTES for MP3 discs

- MP3 discs (either CD-R or CD-RW) require a longer readout time, due to the complexity of the folder/file configuration.
- When making an MP3 disc, select ISO 9660 Level 1 or Level 2 as the disc format.
- Some MP3 discs may not be played back because of their disc characteristics or recording conditions.
- The unit does not support “packet writing” of discs.
- If there are any tracks (files) which are stored on a disc directly and do not belong to any group (folder), the unit recognizes them as belonging to a particular group.
- The unit does not output a digital audio signal from the DVD OPTICAL DIGITAL OUT terminal when playing back an MP3 disc.
- The unit plays back groups/tracks on an MP3 disc in alphabetical order.

Ex.: When there are three title groups [one], [two] and [three] on a disc:

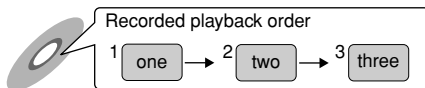

The playback order on this unit is [one], [three] then [two].

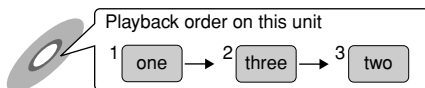

Tracks in a group are played back in the same way.

An MP3 disc on the market may be played back in a different order from the order printed on its sleeve.

### Unavailable functions for MP3 disc

- There are some restriction for playback of MP3 discs. Following functions are not available for MP3 discs.
  - Screen saver function (See page 28.)
  - Forward/Reverse search (See page 33.)
  - A-B repeat (See page 36.)
  - Time search (See page 43.)
  - 3D PHONIC (See page 48.)
  - Resume playback (See page 58.)
- This unit cannot show the names of tracks (files) and groups (folders) on an MP3 disc.

#### 1 Load a disc.

#### 2 Press DVD ▷/|| on the main unit (or DVD SELECT ► on the remote control).

After reading the disc contents, playback starts.

- The disc playing information appears on the display.

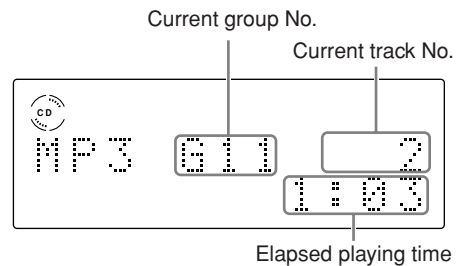

To stop play for a moment, press DVD ▷/|| (or || on the remote control).

While paused, the elapsed playing time and the disc indicator flash on the display.

- To start playback again, press DVD ▷/|| again (or press DVD SELECT ► on the remote control).

To stop playing, press ■.

#### To go to another track

Press |◀◀ or ▶▶| during playback.

- |◀◀: Goes back to the beginning of the current or previous tracks.
- ▶▶|: Skips to the beginning of the next or succeeding tracks.



#### While playback is stopped

You cannot select a track. The |◀◀ and ▶▶| buttons works to select groups.

## To go to another group

### On the remote control ONLY:

Press GROUP SKIP ◀◀ or GROUP SKIP ▶▶ while holding down SHIFT during playback.

- GROUP SKIP ◀◀: Goes back to the previous groups.
- GROUP SKIP ▶▶: Skips to the beginning of the next or succeeding groups.



#### While playback is stopped

You can select a group by pressing ◀◀ or ▶▶.

## To go to a particular group or track directly using the number buttons

### On the remote control ONLY:

#### To select the group you want to play

Press the number buttons to select a group number (up to 99) while playback is stopped.

Ex.: To select number 5, press 5.

To select number 10, press 10.

To select number 20, press +10 then 10.

To select number 23, press +10, +10 then 3.

#### To select the track you want to play

Press the number buttons to select a track number (up to 254) during playback.

Ex.: To select number 5, press 5.

To select number 10, press 10.

To select number 20, press +10, +10 then 0.

To select number 23, press +10, +10 then 3.

To select number 150, press +10 fifteen times, then 0.

## To show the on-screen indication

You can show the following information on the TV while playing back a disc.

### On the remote control ONLY:

To show the on-screen indication, press ON SCREEN while playing a MP3 disc.

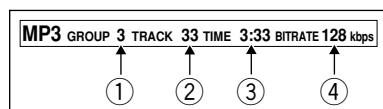

- ① : Current group number
- ② : Current track number
- ③ : Elapsed playing time of the current track
- ④ : Transmission rate\*

\* The transmission rate will change according to the recording conditions. This is not a malfunction.

To erase the on-screen indication, press ON SCREEN again.

## Searching for a Particular Point

Available for: DVD SVCD VCD Audio CD

You can search for a particular portion while playing a disc —Forward/Reverse search.

- When playing a DVD, SVCD, or VCD disc, no sound comes out during Forward/Reverse Search.

### On the remote control:

#### Forward search

To fast-forward the chapter or track, press ▶▶ while playing a disc.

- Each time you press the button, the search speed increases.

#### Reverse search

To fast-reverse the chapter or track, press ◀◀ while playing a disc.

- Each time you press the button, the search speed increases.

To go back to normal play, press DVD SELECT ▶ (or DVD ▷/|| on the main unit).



When playing a DVD, SVCD, or VCD disc The current search speed (x2 to x60) appears on the TV.

**On the main unit:****Forward search**

To fast-forward the chapter or track, press and hold ►► while playing a disc.

- If you keep holding down the button for a certain period of time, the search speed increases.

**Reverse search**

To fast-reverse the chapter or track, press and hold ◀◀ while playing a disc.

- If you keep holding down the button for a certain period of time, the search speed increases.

To go back to normal play, release the button.



When playing a DVD, SVCD, or VCD disc

The current search speed (x5 and x20) appears on the TV.

## Playing Back by Using the Disc Menu

Available for:  DVD  SVCD  VCD

Some DVDs are recorded with their own menus which show their contents. SVCDs or VCDs with the Playback Control (PBC) function also have their own menus, such as lists of songs. You can play back the discs by using these menus.

**■ When playing a DVD**

DVD discs generally have their own menus which show the disc contents. These menus contain various items such as titles of movies, names of songs, or artist information, and display them on the TV screen. You can play back by using these menus.

**On the remote control ONLY:****1** Press TOP MENU or MENU.

The menu appears on the TV.

Ex.:

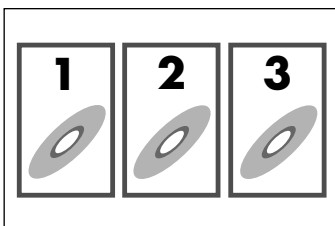

Normally, a DVD containing more than one title will list the titles in a title menu. Press TOP MENU to show the title menu.

Some DVD discs may also have a different menu which is shown by pressing MENU.

- See the instructions of each DVD disc for its particular menu.

**2** Use Cursor ◀/▶/▲/▼ to select a desired item, then press ENTER.

Playback of the selected item starts.

- With some discs, you can also select items by entering the corresponding number using the number buttons.

**■ When playing a SVCD or VCD**

When a SVCD or VCD with the Playback Control function (PBC) is detected, the PBC indicator lights up on the display. The PBC function allows you to operate the SVCD or VCD by using menus.

When you start playback, a menu automatically appears on the TV screen.

- A menu may be a list of items, divided screens, or some moving pictures. (See “PBC operation concept” on the next page.)
- See also the instructions of each disc for its particular menu.

Ex.:

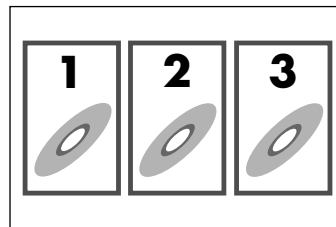
**On the remote control ONLY:**

To select the number of the desired item, press the number buttons.

Ex.: To select number 5, press 5.

To select number 10, press 10.

To select number 20, press +10, +10 then 0.

To select number 23, press +10, +10 then 3.

The system starts playback from the selected item.

To return to the previous menu, press RETURN.

**When “NEXT” or “PREVIOUS” is shown on the menu:**

You can go to other pages of the menu.

- To go to the next page, press NEXT (►►).
- To return to the previous page, press PREV. (◀◀).

## PBC operation concept

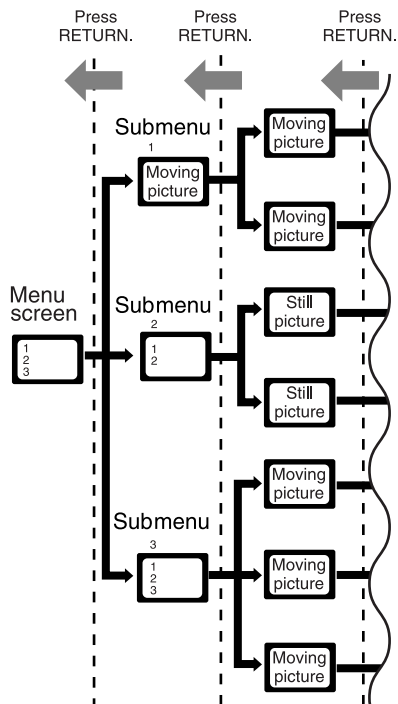

### To cancel the PBC function:

- 1 Press **■** during playback.  
Playback stops.
- 2 Press the number buttons to select the track number you want to play.  
Playback starts from the selected track without the PBC function.

To activate the PBC function again, press **■** once or twice to stop playback completely, then press DVD SELECT **▶**.

- When you use the Resume function, press **■** twice to stop playback completely.

You can also activate the PBC function during playback without the PBC function as follows:

- 1 Press PLAY MODE.  
The play mode screen appears on the TV.  

  - 2 Use Cursor **◀/▶** to move **▶** to "PBC CALL," then press ENTER.
- You cannot cancel the PBC function from the play mode screen.

## Repeating Playback

### Repeat play

Available for: DVD SVCD VCD Audio CD MP3

You can repeat playback of disc's contents as follows:

- **For DVD:** You can repeat the current title or chapter.
  - The repeat play cannot be used on some DVD discs.
  - For DVD, you can select "REPEAT" only during playback.
- **For SVCD, VCD, Audio CD:** You can repeat a track or all tracks.
  - You can only use the repeat play on SVCD or VCD without the PBC function.
- **For MP3 disc:** You can repeat a group or all groups.

### On the remote control ONLY:

- 1 Press PLAY MODE before or during play.  
The play mode screen appears on the TV.



Ex.: While playback is stopped.



Ex.: During DVD playback.

- 2 Press Cursor **◀/▶** to move **▶** to "REPEAT."

- 3 Press ENTER repeatedly to select the repeat play mode you want.

The selected repeat mode is shown on the TV and in the main display of this unit.

- Each time you press the button, the repeat play mode changes as follows:

### For DVD:

Ex.: During playback.

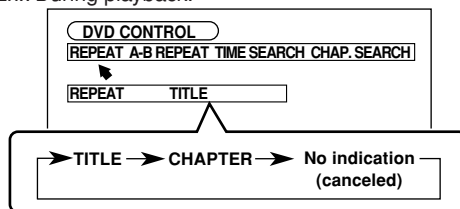

- **TITLE:** Current title will be repeated.
- **CHAPTER:** Current chapter will be repeated.

### For SVCD, VCD, or Audio CD:

Ex.: During VCD playback.

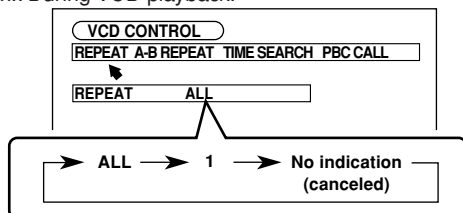

- **ALL:** All tracks on the disc or all tracks in the program will be repeated.
- **1:** Current track will be repeated.

### For MP3 disc:

Ex.: During playback.

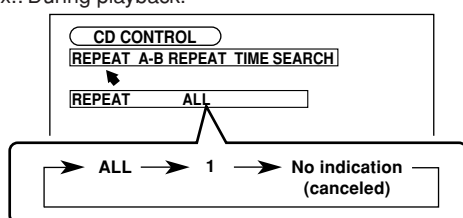

- **ALL:** All groups on the disc or all groups in the program will be repeated.
- **1:** Current group will be repeated.

The corresponding repeat mode indicators light up on the display.

- When "TITLE" or "ALL" is selected:  
The **C ALL** indicator lights up on the display.
- When "CHAPTER" or "1" is selected:  
The **C** indicator lights up on the display.

To erase the play mode screen, press PLAY MODE.

To stop playing, press ■.

To cancel the repeat play, perform steps 1 and 2, then press ENTER repeatedly until the repeat mode indication disappears from the TV.

"REPEAT OFF" appears in the main display and the repeat mode indicator goes off.

To erase the play mode screen, press PLAY MODE.

- Pressing ■ during the repeat play of DVD stops playback and cancels the repeat play.
- Ejecting the disc or turning off the unit will also cancel the repeat play.

### ■ A-B repeat play

Available for: DVD SVCD VCD Audio CD

While playing, you can select a portion you want to repeat.

- During the program play (see page 37), random play (see page 39), or repeat play, you cannot perform the A-B repeat play.
- You cannot perform the A-B repeat play between different chapters or different titles on a DVD.

#### On the remote control ONLY:

#### 1 Press PLAY MODE during play.

The play mode screen appears on the TV.

#### 2 Press Cursor ▶/◀ to move to "A-B REPEAT."

**REPEAT A-B REPEAT TIME SEARCH CHAP. SEARCH**

Ex.: While a DVD is played back.

#### 3 Press ENTER at the starting point from which you want to repeat (point A).

The A-B repeat indication appears on the TV.

**A 1:12:34 → B \_:\_\_:\_\_**

- The following indication also appears on the display.

A-B repeat indicator

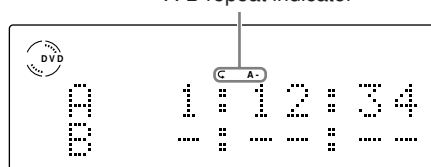

#### 4 Press ENTER again at the end point to which you want to repeat (point B).

The A-B repeat play begins.

The unit automatically locates point A and starts repeating the portion between points A and B.

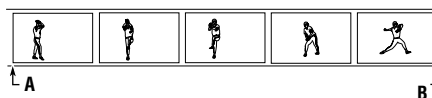

To erase the play mode screen, press PLAY MODE.

To cancel the A-B repeat play, press ENTER.

The A-B repeat play is canceled and normal playback continues from that point.

## Programming the Playing Order —Program Play

Available for: DVD SVCD VCD Audio CD MP3

You can arrange the order of playback before you start playing.

- **For DVD:** You can arrange the order in which the titles play.
  - The program play cannot be used on some DVD discs.
- **For SVCD, VCD, Audio CD:** You can arrange the order in which the tracks play.
- **For MP3 disc:** You can arrange the order in which the groups play.
  - You can program up to 18 steps.
  - You cannot perform the program play while the random play is activated. (See page 39.)

### On the remote control ONLY:

- 1** Load a disc.
- 2** Press DVD SELECT ►, then ■. The source is changed to the DVD player and playback is stopped.
- 3** Press PLAY MODE. The play mode screen appears on the TV.
 

REPEAT	PROGRAM	RANDOM
--------	---------	--------
- 4** Press Cursor ►/◀ to move to “PROGRAM,” then press ENTER. The program screen appears on the TV.

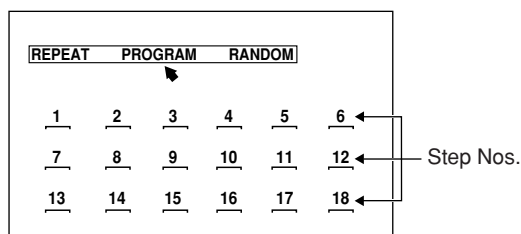

The PRGM (program) indicator lights up on the display.

- 5** Press the number buttons to enter a title, track, or group number you want to program.

The selected number is shown on the program screen.  
Ex.: To select number 5, press 5.

- To select number 10, press 10.
- To select number 20, press +10, +10 then 0.
- To select number 23, press +10, +10 then 3.

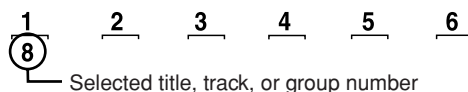

- 6** To program other titles, tracks, or groups, repeat step 5.

REPEAT	PROGRAM	RANDOM
--------	---------	--------

1	2	3	4	5	6
8	3	9	4	18	15
7	8	9	10	11	12
12	11	1	2	5	7
13	14	15	16	17	18
16	6	13	10	22	14

- You can also check the program settings on the display.

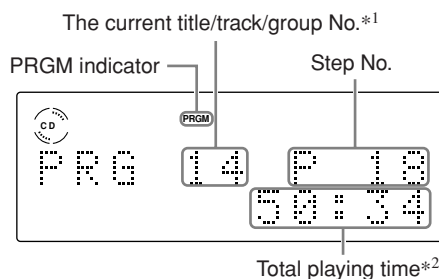

Ex.: When an Audio CD is loaded and 18 tracks have been programmed.

- \*1 • When a DVD is loaded, “T” (title) appears before the number.
- When an MP3 disc is loaded, “G” (group) appears before the number.

\*2 When a DVD or an MP3 disc is loaded, the total playing time does not appear.

- 7** Press DVD SELECT ►.

The program screen goes off and your program starts playing.

- If you press REC on the main unit, you can start recording on a tape. (See page 51.)



**To stop playing, press ■.**

Playback stops, but the program play is still activated.

- To exit from the program play, see “To exit from the program play” on the right column.

**To go to the next steps, press ►►.**

- You cannot go back to the previous steps by pressing ◀◀.

**If your entry is ignored**

You have tried to program a title/track/group number that does not exist on the disc (for example, selecting track 14 on a disc that only has 12 tracks). Such entries are ignored.

**If the total playing time exceeds 100 minutes**

The total playing time in the main display will not be shown. (“--:--” will appear.)

**To check the programmed contents****On the TV:**

Press PLAY MODE. The programmed contents appear on the TV.

To erase the play mode screen, press PLAY MODE.

**On the display:**

Press ►► or ◀◀ while the program play is stopped.

- ►►: Shows the programmed tracks in the programmed order.
- ◀◀: Shows them in the reverse order.

**To modify the program**

You can modify the program before or after playing.

**To show the program screen:**

- 1 Press PLAY MODE while the program play is stopped. The program screen appears on the TV.
  - If you press the button during playback, the program screen appears on the TV, but you cannot modify your program.
- 2 Press Cursor ►/◀ to move  to “PROGRAM.” Now you can modify your program.

**To erase the last step, press CANCEL.**

- Each time you press the button, the last programmed step is erased from the program.

**To add steps in the program before play,** simply select the numbers you want to add by pressing the number buttons.

**To erase the entire program,** press and hold CANCEL for about 3 seconds.

- Ejecting the disc or turning off the unit also erase the program.

**To exit from the program play**

When the program play is stopped, perform steps **3** and **4** on page 37 so that the program screen disappears from the TV.

“PROGRAM OFF” appears in the main display and the PRGM (program) indicator goes off.

To erase the play mode screen, press PLAY MODE.

- Each time you press ENTER in step **4**, the program play turns on and off.
- Ejecting the disc or turning off the unit will also cancel the program play and erase the program.

## Playing at Random—Random Play

Available for:  DVD  SVCD  VCD  Audio CD  MP3

You can play disc's contents in random order.

- **For DVD:** You can play the titles in random order.
  - The random play cannot be used on some DVD discs.
- **For SVCD, VCD, Audio CD:**
  - You can play the tracks in random order.
- **For MP3 disc:**
  - You can play the groups in random order.
- You cannot perform the random play while the program play is activated. (See page 37.)

### On the remote control ONLY:

- 1** Load a disc.
- 2** Press DVD SELECT ►, then ■.  
The source is changed to the DVD player and playback is stopped.
- 3** Press PLAY MODE.  
The play mode screen appears on the TV.
- 4** Press Cursor ►/◀ to move  to “RANDOM,” then press ENTER.  
“RANDOM” appears under the play mode screen.

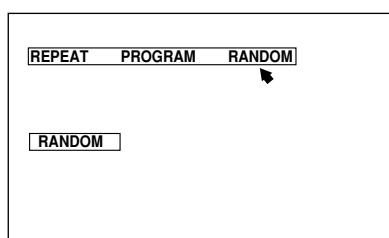
“RANDOM ON” appears in the main display and the RANDOM indicator lights up.

### 5 Press DVD SELECT ►.

Playback starts in random order.

The random play ends when all titles, tracks, or groups are played once.

- If you press REC on the main unit, you can start recording on a tape. (See page 51.)

**To skip the playing title, track, or group, press ►►.**

- You cannot go back to the previous title, track, or group by pressing ◀◀.

**To stop playing, press ■.**

Playback stops, but the random play is still activated.

- To exit from the random play, see “To exit from the random play” below.

### To exit from the random play

When the random play is stopped, perform steps **3** and **4** so that “RANDOM” disappears from the TV.

“RANDOM OFF” appears in the main display and the RANDOM indicator goes off.

To erase the play mode screen, press PLAY MODE.

- Each time you press ENTER in step **4**, the random play mode turns on and off.
- Ejecting the disc or turning off the unit will also cancel the random play.

# Playing Back Tapes

The buttons emphasized in the illustration below are used and explained in the following section (page 41).

## Remote control

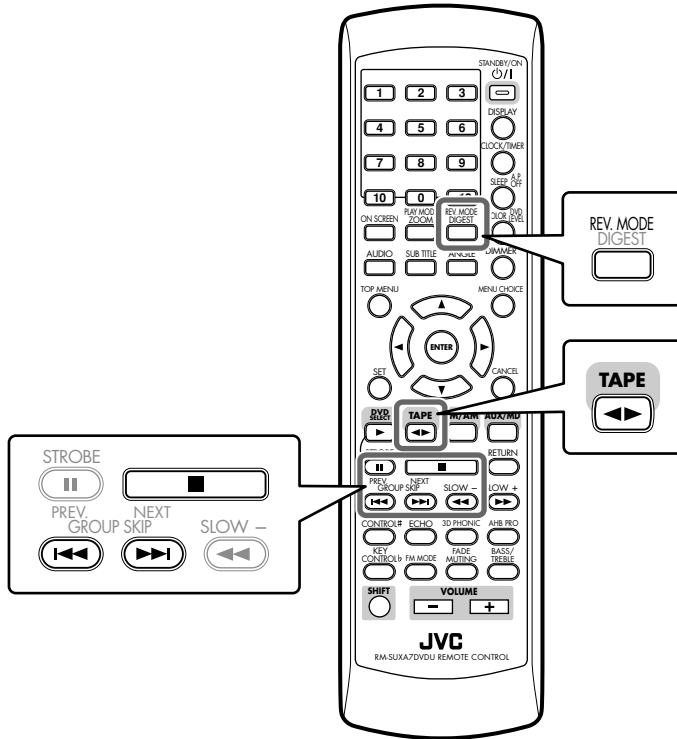

## Main unit

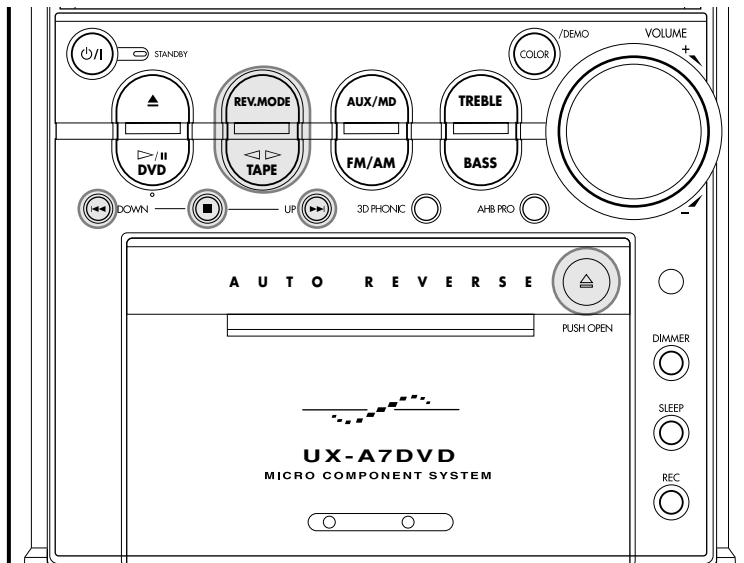

## Playing Back a Tape

You can play back type I tapes.

### 1 Push $\triangle$ (PUSH OPEN).

The cassette holder opens.

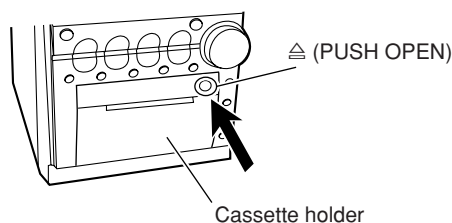

### 2 Put a cassette in with the exposed part of the tape down.

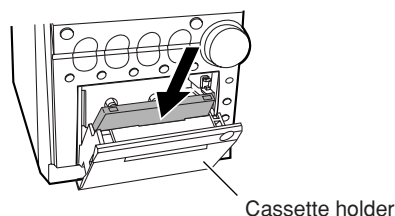

### 3 Push $\triangle$ (PUSH OPEN) gently to close the cassette holder.

When the unit is turned on, the TAPE  $\square\square$  indicator appears on the display.

### 4 Press TAPE $\blacktriangle\blacktriangleright$ .

Playback starts (if the unit is in standby, the unit automatically turns on).

**To change the tape direction, press TAPE  $\blacktriangle\blacktriangleright$ .**

- Each time you press the button, the tape direction changes as follows:

- $\blacktriangle\blacktriangleright$  : Plays the front side (left to right).
- $\blacktriangle\blacktriangleright$  : Plays the reverse side (right to left).

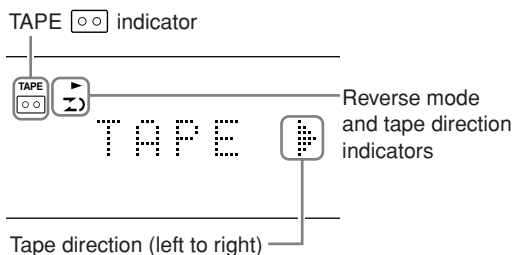

When the tape plays to the end, the deck automatically stops if the reverse mode is set to  $\blacktriangle\blacktriangleright$  or  $\blacktriangle\blacktriangleright$ . (See “To play both sides—Reverse mode” on the right column.)

**To stop during play, press  $\blacksquare$ .**

**To fast-wind to the left, press  $\blacktriangle\blacktriangle\blacktriangle\blacktriangle$ .**

**To fast-wind to the right, press  $\blacktriangleright\blacktriangleright\blacktriangleright\blacktriangleright$ .**

**To remove the cassette, push  $\triangle$  (PUSH OPEN).**

The TAPE  $\square\square$  indicator goes off.



DO NOT push  $\triangle$  (PUSH OPEN) during tape play.

### To play both sides—Reverse mode

You can set the deck to play just one side or both sides of a tape once, or both sides continuously.

Press REV. MODE.

- Each time you press the button, the reverse mode changes as follows:

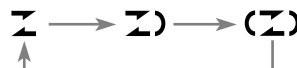

- $\square$  : Plays back only one side (front or reverse).
- $\square$  : Plays back the front and reverse sides once.
- $\square$  : Plays back both front and reverse sides continuously.



- The use of the C-120 or thinner tape is not recommended, since characteristic deterioration may occur and this tape easily jams in the pinch rollers and the capstans.
- You can also play back type II and type IV tapes; however, the sound quality (tone) may not be reproduced properly.

# Special Disc Playback

The buttons emphasized in the illustration below are used and explained in the following section (pages 43 to 48).

    shows the types of discs the operation is available for.

- The functions in this section do not work for MP3 discs.

## Remote control

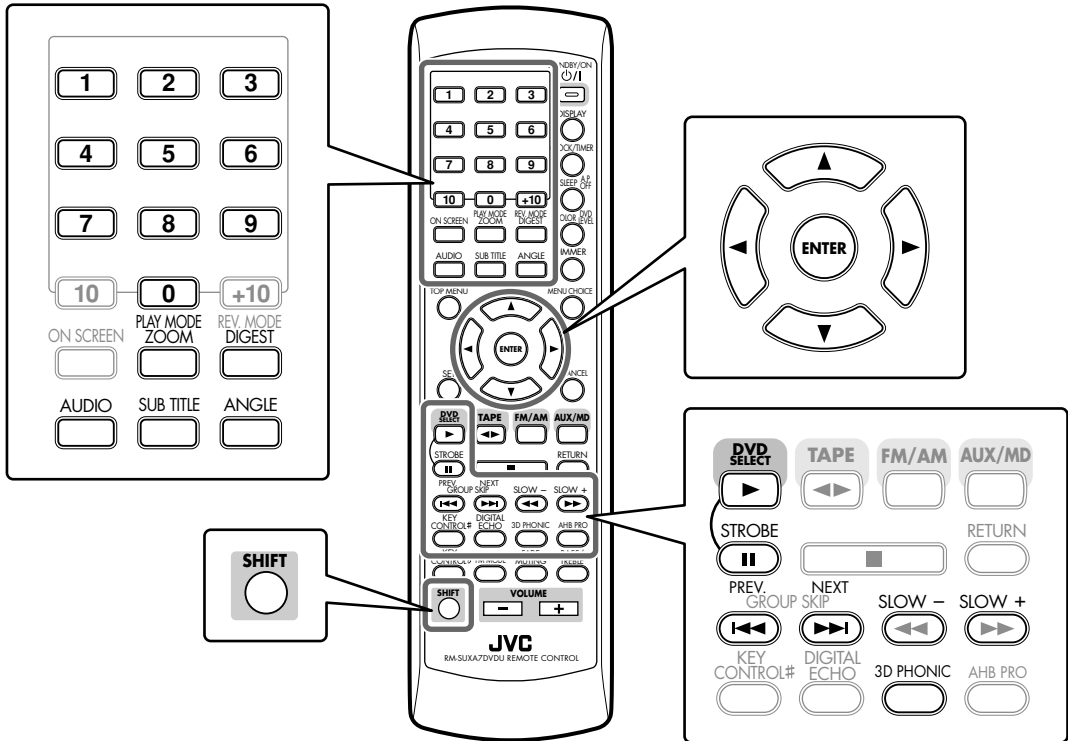

## Main unit

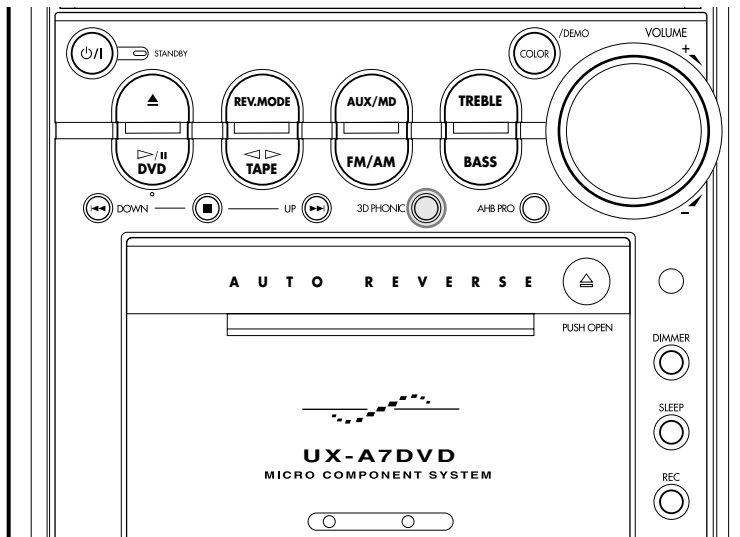

**IMPORTANT:**

Before performing any operations for DVD, SVCD and VCD, make sure of the following:

- Check the connection with the TV.
- Turn on the TV and select the correct input on the TV to view the pictures or on-screen menus/indications on the TV screen.
- Select the correct color system.

## Locating a Scene by Selecting the Chapter Number—Chapter Search

Available for:  DVD

If the current title is divided into chapters, you can skip to the chapter you want by selecting the chapter number.

- You cannot perform this function while the program or the random play is activated.

### On the remote control ONLY:

#### 1 Press PLAY MODE during play.

The play mode screen appears on the TV.

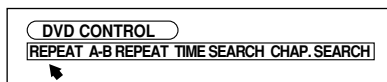

#### 2 Press Cursor ▶/◀ to move to “CHAP. SEARCH,” then press ENTER.

“GO TO CHAPTER =” appears on the TV.

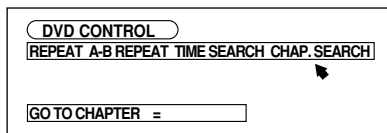

- The chapter search indication appears in the main display.

#### 3 Enter a chapter number by pressing the number buttons (0 to 9).

- The 10 button works to enter “0.”
- Ex.: To enter chapter number 3, press 3.  
To enter chapter number 23, press 2 and 3.

To cancel misentry, repeat step 3 until the correct number appears after “=”.

#### 4 Press ENTER.

Playback starts from the beginning of the selected chapter.

To erase the on-screen indication, press PLAY MODE again.

## Locating a Position by Selecting the Playing Time—Time Search

Available for:  DVD  SVCD  VCD  Audio CD

You can play a disc from the position you want by specifying the elapsed time from the beginning of the current title or track.

- You cannot use this function while a SVCD or VCD is played back with the PBC function.
- You cannot use this function for some DVDs without time information.
- You cannot perform this function while the program or the random play is activated.

### On the remote control ONLY:

#### 1 Press PLAY MODE during play.

The play mode screen appears on the TV.

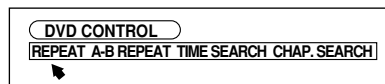

#### 2 Press Cursor ▶/◀ to move to “TIME SEARCH,” then press ENTER.

“GO TO” appears on the TV.

- You can specify the time as follows:
  - For DVD: Hours, minutes, and seconds of the current title
  - For SVCD, VCD, or Audio CD: Minutes and seconds of the current track

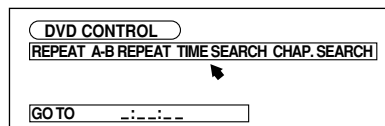

Ex.: While an DVD is played back.

- The time search indication appears in the main display.

### 3 Enter the playing time by pressing the number buttons (0 to 9).

- The 10 button works to enter "0."

Ex.: To play back from the position of "0:23:45."

	<input type="text" value="_:__:__"/>
Press 0	
↓	<input type="text" value="0:__:__"/>
Press 2	
↓	<input type="text" value="0:2_:__"/>
Press 3	
↓	<input type="text" value="0:23:__"/>
Press 4	
↓	<input type="text" value="0:23:4_"/>
Press 5	
	<input type="text" value="0:23:45"/>

(Always enter all digits.)

**To cancel misentry,** press Cursor .

- Each time you press the button, the last number you entered is erased.

### 4 Press ENTER.

Playback starts from the selected position of the current title or track.

**To erase the on-screen indication,** press PLAY MODE again.

## Viewing the Desired Chapters/Tracks—Digest

Available for:  DVD  SVCD  VCD

You can view nine opening scenes of chapters or tracks at a time and select the desired scene from those displayed on the TV directly.

- You cannot use this function while a SVCD or VCD is played back with the PBC function.
- You cannot perform this function while the program or the random play is activated.

**On the remote control ONLY:**

### 1 Press DIGEST while holding down SHIFT.

The digest screen appear in sequence (up to nine pictures at a time) on the TV.

This scene is selected.



#### For DVD:

- While stopped:  
The opening scenes of each title appear.
- During playback:  
The opening scenes of each chapter in the current title appear.

#### For SVCD or VCD:

The opening scenes of each track appear.

### 2 Press Cursor /▶/▲/▼ to move to a scene you want to start playback.

- If there are more than nine scenes, you can move to the next digest screen (page).

**To show other pages of the digest screen,**

- To show the next page, press NEXT (▶▶).
- To show the previous page, press PREV. (◀◀).

Continued next page 

- You can also show other pages as follows:

To show the previous page, press Cursor ◀▶/▲/▼ to select the left top scene, then press Cursor ◀.

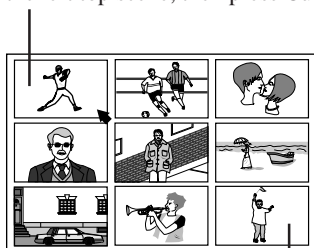

To show the next page, press Cursor ◀▶/▲/▼ to select the right bottom scene, then press Cursor ▶.

### 3 Press ENTER.

Playback starts with the selected scene.



#### With some discs

Depending on the contents, it may take some time before all the scenes appear on the TV.

## Selecting Multi-Angle Views

Available for: DVD

While playing a disc containing multi-angle views, you can view the same scene at different angles.

### To change angle views

On the remote control ONLY:

#### 1 Press ANGLE.

The on-screen indication appears on the TV.



Ex.: When the disc has 3 angle views.

#### 2 Press Cursor ▶/◀ to select a view angle you want.

- Each time you press the button, the view angle changes as follows:

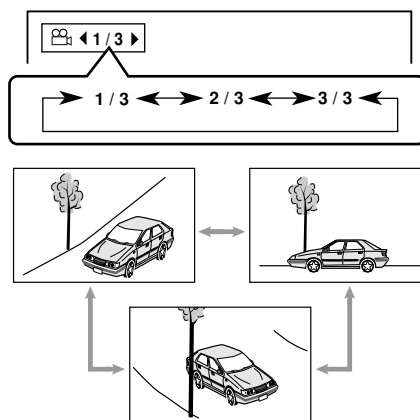

Ex.: When the disc has 3 angle views.

- You can also select a view angle by pressing ANGLE repeatedly.

To erase the on-screen indication, press ENTER.

### To show all angle views

On the remote control ONLY:

#### 1 Press and hold ANGLE for more than 1 second.

Up to nine pictures of the different camera angles recorded on the disc appear on the TV.

This picture is selected.

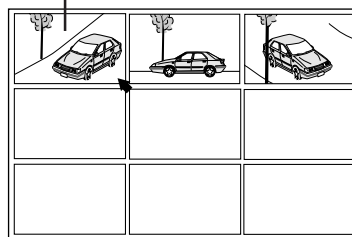

Ex.: When 3 angles are recorded.

#### 2 Press Cursor ◀▶/▲/▼ to move to the desired view.

#### 3 Press ENTER.

The angle list goes off, and playback starts at the selected view angle.



While the angle list is shown on the TV You cannot listen to the sound.



## Selecting the Audio Language or Sound

Available for:  DVD  SVCD  VCD

While playing a disc containing audio languages (sound tracks), you can select the language (sound) to listen to.

### On the remote control ONLY:

#### 1 Press AUDIO.

The on-screen indication appears on the TV.

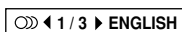

Ex.: While a DVD which has 3 selections is played back.

#### 2 Press Cursor / to select an audio language (sound) you want.

- Each time you press the button, the audio language (sound) changes as follows:

##### For DVD:

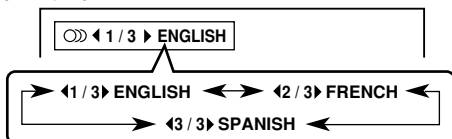

Ex.: When the disc has 3 selections—English, French, and Spanish.

##### For SVCD:

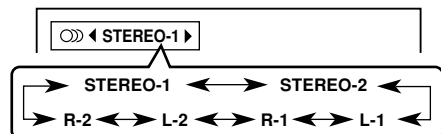

- STEREO-1/STEREO-2:** To listen to normal stereo playback of STEREO-1 or 2 channel.
- L-1/L-2:** To listen to the L (left) 1 or 2 audio channel.
- R-1/R-2:** To listen to the R (right) 1 or 2 audio channel.

##### For VCD:

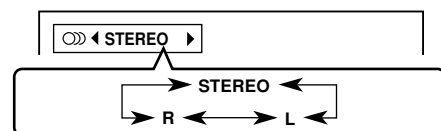

- STEREO:** To listen to normal stereo playback.
  - L:** To listen to the L (left) audio channel.
  - R:** To listen to the R (right) audio channel.
- You can also select a audio language (sound) by pressing AUDIO repeatedly.

To erase the on-screen indication, press ENTER.



When selecting a language for some DVDs Its abbreviation will be shown. (See page 69.)

## Selecting the Subtitle Language

Available for:  DVD  SVCD

While playing a disc containing subtitles in different languages, you can select the subtitle to be displayed on the TV.

### On the remote control ONLY:

#### 1 Press SUB TITLE.

The on-screen indication appears on the TV.

- Each time you press the button, the subtitle turns on and off.

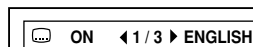
 ENGLISH" data-bbox="562 432 746 456"/>

Ex.: While a DVD which has 3 selections is played back.

#### 2 Press Cursor / to select a subtitle language you want.

- Each time you press the button, the subtitle language changes as follows:

##### For DVD:

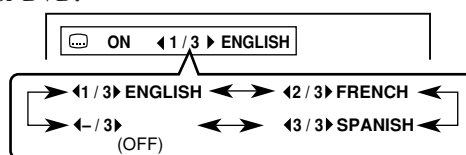

Ex.: When the disc has 3 selections—English, French, Spanish and no subtitle (OFF).

##### For SVCD:

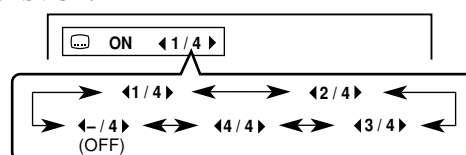

Four subtitle channels shows whether or not any subtitles are actually available.

To show no subtitle, select “-.”

To erase the on-screen indication, press ENTER.



When selecting a language for some DVDs Its abbreviation will be shown. (See page 69.)

## Playing a Still Picture/Frame-by-Frame

Available for:  DVD  SVCD  VCD

You can freeze a picture and advance the still picture frame by frame.

**On the remote control ONLY:**

**1** Press **II** once during play.  
A still picture appears on the TV.

**2** Press **II** repeatedly.  

- Each time you press the button, the still picture advances frame by frame.

To go back to normal play, press DVD SELECT ►.

## Showing Continuous Still Pictures—Strobe

Available for:  DVD  SVCD  VCD

You can view the nine continuous still pictures.

**On the remote control ONLY:**

**1** Press **STROBE** during play at the point where you want to view continuous still pictures.  
A still picture appears on the TV.

**2** Press and hold **STROBE** for more than 1 second.  
Nine continuous still pictures appear on the TV.  

- Each time you press the button, next nine still pictures appear.

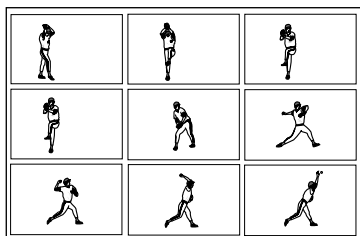

To cancel the strobe play, press and hold **STROBE** so that a still picture resumes, then press DVD SELECT ► to go back to normal play.



Nine screens of the same pictures appear and is played frame-by-frame at normal speed in following cases

- If you press and hold **STROBE** for more than 1 second during normal playback.
- If you press DVD SELECT ► after pressing and holding **STROBE** in step 2.

## Playing Back in Slow-Motion—Slow

Available for:  DVD  SVCD  VCD

You can enjoy the slow-motion playback.

- Reverse slow-motion playback cannot be used on some SVCDs or VCDs.

**On the remote control ONLY:**

**1** Press **II** once during play.  
A still picture appears on the TV.

**2** Press **SLOW +** or **SLOW -**.  

- Each time you press **SLOW +**, forward slow-motion speed changes as follows:

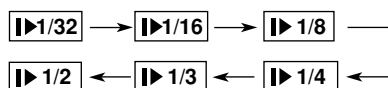

- Each time you press **SLOW -**, reverse slow-motion speed changes as follows:



No sound is heard during the slow-motion playback.

To go back to normal play, press DVD SELECT ►.

## Zooming in the Picture—Zoom

Available for:  DVD  SVCD  VCD

You can zoom a picture by 2 times.

### On the remote control ONLY:

#### 1 Press ZOOM while holding down SHIFT.

“ZOOM” appears on the TV.

- Each time you press the buttons, the picture is zoomed in and out alternately.

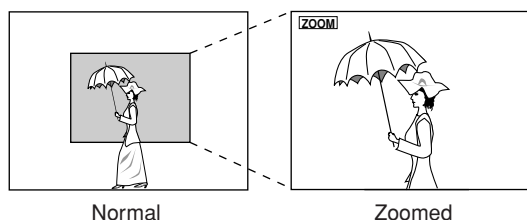

#### 2 Press Cursor /▶/▲/▼ to select the position you want to zoom in.

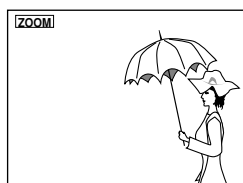

To go back to normal play, press ZOOM while holding down SHIFT.



While zoomed in, the picture may look coarse.

## Enjoying Virtual Surround Sound —3D PHONIC

Available for:  DVD  SVCD  VCD  Audio CD

Using the 3D PHONIC function, you can get a simulated surround effect.

- For SVCD or VCD, you can use the 3D PHONIC function only when the AUDIO setting is set to STEREO. (See page 46.)

### Press 3D PHONIC repeatedly to select the 3D PHONIC mode you want.

- Each time you press the button, the 3D PHONIC mode changes as follows:

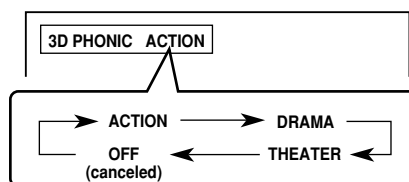

- **ACTION\***: Suitable for action movies and sports programs in which sounds dynamically move.
  - **DRAMA**: Natural and warm sound. You can enjoy movies in a relaxed mood.
  - **THEATER**: You can enjoy sound effects like in a major theater in Hollywood.
- \* When a DVD recorded in Dolby Digital containing more than 3 channels, “ACTION” does not appear.

When the 3D PHONIC function is activated, the 3D PHONIC indicator lights up on the display.

To erase the on-screen indication, press ENTER.

- If no operation is done for about 5 seconds, the on-screen display goes off.







### More about the 3D PHONIC function

- The 3D PHONIC function works correctly when playing back discs recorded in the Dolby Surround or Dolby Digital 5.1 ch format. It also works when playing back any discs other the above, but does not provide the correct effect.
- The 3D PHONIC function does not affect the DTS or Dolby Digital signal from the DVD OPTICAL DIGITAL OUT terminal.
- If a DVD whose sound is recorded in Linear PCM, you cannot use the 3D PHONIC function.
- While you use the 3D PHONIC function, the “DOWN MIX” and “COMPRESSION” settings in the AUDIO menu are deactivated temporarily. (See pages 57 and 58.)
- For SVCD or VCD, when the 3D PHONIC function is active, changing the AUDIO setting cancels the 3D PHONIC function. (See page 46.)

# Recording

The buttons emphasized in the illustration below are used and explained in the following section (pages 50 to 52). For recording operations, you primarily use the buttons on the main unit.

     shows the types of discs the operation is available for.

## Main unit

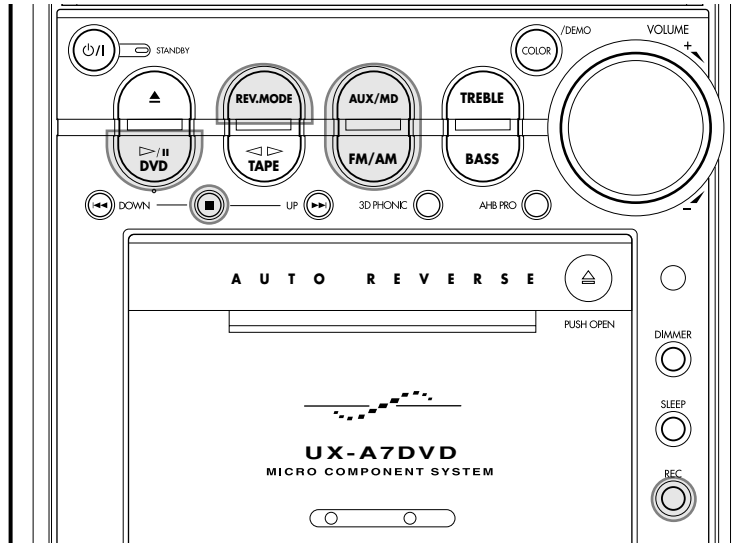

## Remote control

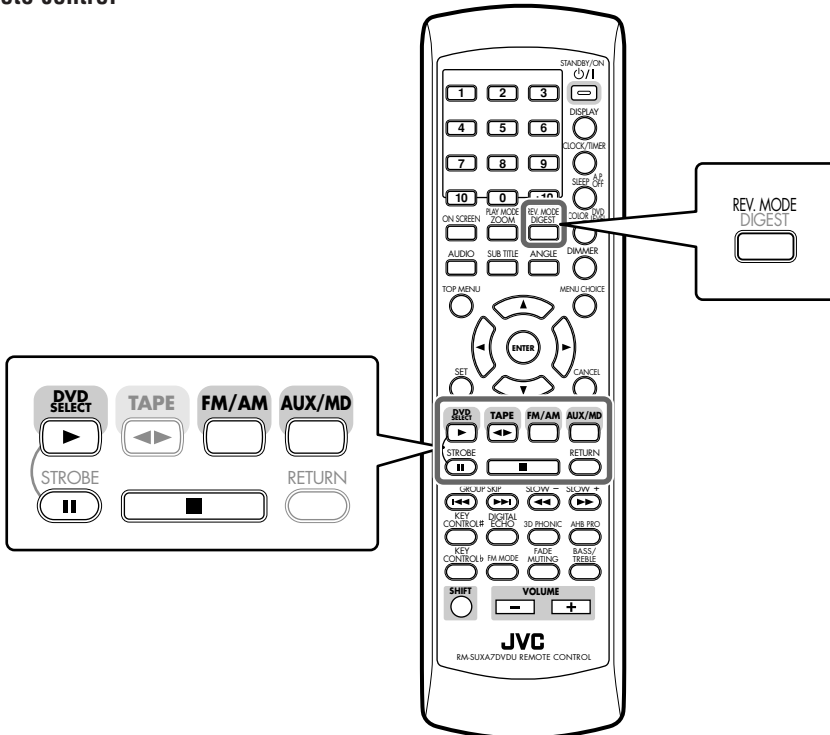

## Before You Start Recording on a Tape

- It may be unlawful to record or play back copyrighted material without the consent of the copyright owner.
- The recording level is automatically set correctly, so it is not affected by the volume level and the tone level adjustment—"BASS" and "TREBLE" (see pages 20 and 21). Thus, during recording you can adjust the sound you are actually listening to without affecting the recording level.
- While recording, you can hear the AHB PRO (Active Hyper Bass Pro) effect through the speakers or headphones. However, the sound is recorded without this effect (see page 21).
- While recording, the 3D PHONIC function (see page 48) or the COMPRESSION function (see page 58) is activated, the sound is recorded with these effects.
- If recordings you have made have excessive noise or static, the unit may be too close to a TV. Place the unit away from the TV.
- You can use only type I tapes for recording.

### To protect your recordings

Cassettes have two small tabs on the back to protect against unexpected erasure or recording.

To protect your recording, remove these tabs.

To re-record on a protected tape, cover the holes with adhesive tape.

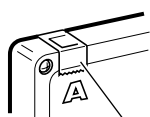

Adhesive tape



Do not use type II and type IV tapes since the unit is not compatible with such tapes.



The use of the C-120 or thinner tape is not recommended, since characteristic deterioration may occur and this tape easily jams in the pinch rollers and the capstans.

### To keep the best recording and playback sound quality

If the heads, capstans, and pinch rollers of the cassette deck become dirty, the following will occur:

- Loss of sound quality
- Discontinuous sound
- Fading
- Incomplete erasure
- Difficulty in recording

### To clean the heads, capstans, and pinch rollers

Use a cotton swab moistened with alcohol.

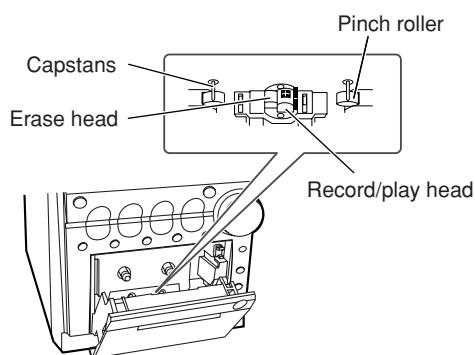

### To demagnetize the head

Turn off the unit, and use a head demagnetizer (available at electronics and audio shops).



### At the start and end of cassette tapes

There is leader tape which cannot be recorded onto. Thus, when recording from discs, FM/AM broadcasts, or external equipment, wind the leader tape first to ensure that the recording will be made without any music part lost.

## Recording a Disc onto a Tape —Disc Synchronized Recording

Available for:     

Using the disc synchronized recording method, you can start and stop disc play and recording at the same time.

- During the disc synchronized recording, some operations which would affect the recording (both audio and video) are prohibited.
- You can use only type I tapes for recording.
- When you want to record onto both sides of a tape, you can set the reverse mode to do so. Recording automatically stops after recording in the ◀ direction. Therefore, make sure that the tape direction is ▶ when recording with the reverse mode on.

### 1 Prepare a disc.

After placing a disc, press DVD ▷/|| (or DVD SELECT ▶ on the remote control), then ■ before going to the next step.

- You can create a program (see page 37) or select the random play mode (see page 39) as you wish.

### 2 Put a recordable cassette into the cassette holder.

### 3 Press REV. MODE to select the reverse mode.

- Each time you press the button, the reverse mode changes as follows:

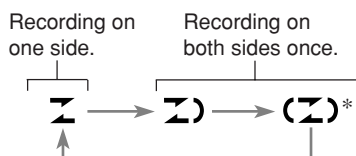

- \*  will be shown during recording when you select .

### 4 Press REC on the main unit.

Recording starts and the REC indicator starts flashing on the display.

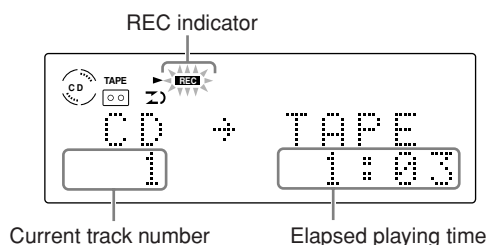

Ex.: An audio CD is now recorded.

- When recording from an DVD, the current title or chapter number does not appear on the display.

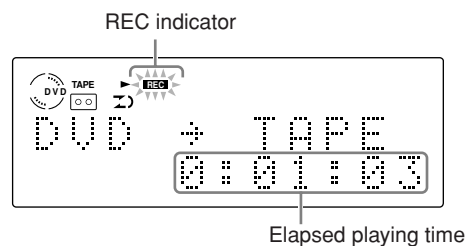

Ex.: A DVD is now recorded.

After recording, both the DVD player and the cassette deck stop automatically.

To stop recording, press ■.



**notes** When recording from some DVDs which have their menu

Playback may not go further from the point where the menu is shown. (You cannot select any item on the menu during recording.) In such a case, stop the recording and select the point where you want to start recording as follows:

- 1 Start disc playback.
- 2 Select the item on the disc menu which you want to record. The selected item starts playback.
- 3 Press || where you want to start recording.
- 4 Press REC to start recording.



**notes** When recording a disc (except DVD and MP3 disc)

- A 4-second blank is automatically made on the tape before each track. To record without the blank, press DVD ▷/|| twice so that disc playback is paused in step 1, then go to next steps.
- When the front side of the tape ends in the middle of a track, the recording on the reverse side starts from the beginning of that track (if the reverse mode is set to ). However, if the front side ends within 12 seconds from the beginning of a track, recording on the reverse side starts from the previous track.

## To record a single track during play

Available for:  SVCD  VCD  Audio CD

- You can do this operation for SVCD or VCD only without the PBC function.

### On the main unit ONLY:

While playing back a track you want to record, press REC.

The playback of the track is stopped, and the same track starts playing from the beginning again. This time, the cassette deck starts recording the track.

- After the track is recorded, both the DVD player and the cassette deck stop automatically.



If you do the above operation for a DVD or an MP3 disc

Recording starts from the point where you press the button and does not stop after the current chapter or track is recorded. (Playback also continues.)



When you press REC while pausing a track

Recording starts from that point.

## Recording Other Sources onto a Tape

You can record from FM or AM broadcasts or the sound from external equipment connected to the AUX/MD jacks onto a tape.

- You can use only type I tapes for recording.
- When you want to record onto both sides of a tape, you can set the reverse mode to do so. Recording automatically stops after recording in the ◀ direction. Therefore, make sure that the tape direction is ▶ when recording with the reverse mode on.

### 1 Prepare the source to record.

#### To record from FM/AM broadcasts:

Press FM/AM to select either “FM” or “AM,” then tune in to the station you want.

- For more detailed tuner operations, see pages 24 to 26.

#### To record from external equipment:

Press AUX/MD to select “AUX/MD” and prepare the external equipment.

- Adjust audio input level through the AUX/MD jacks if necessary. (See page 23.)
- For operation of external equipment, see its manual also.

### 2 Put a recordable cassette into the cassette holder.

### 3 Press REV. MODE to select the reverse mode.

- Each time you press the button, the reverse mode changes as follows:

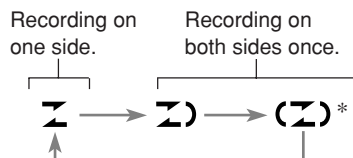

- \* Z will be shown during recording when you select Z.

### 4 Press REC on the main unit.

Recording starts and the REC indicator starts flashing on the display.

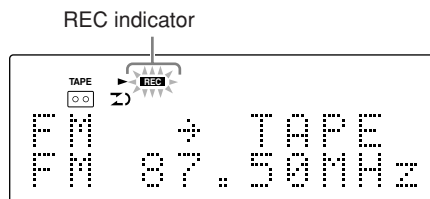

Ex.: When recording from an FM broadcast.

- When recording from external equipment, start playback on external equipment after the following indication appears in the main display.

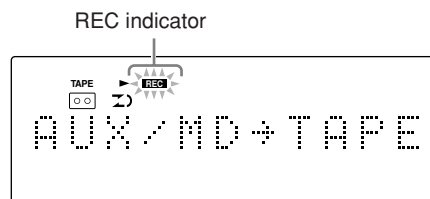

To stop recording, press ■.

# Using the Microphone

The buttons emphasized in the illustration below are used and explained in the following section (page 54).

## Remote control

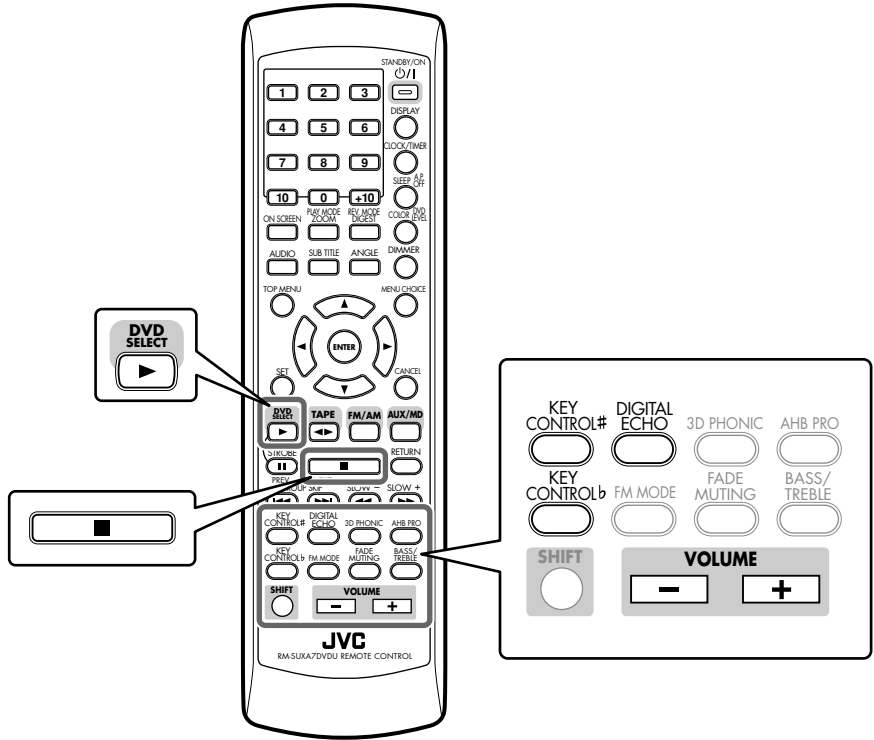

## Main unit

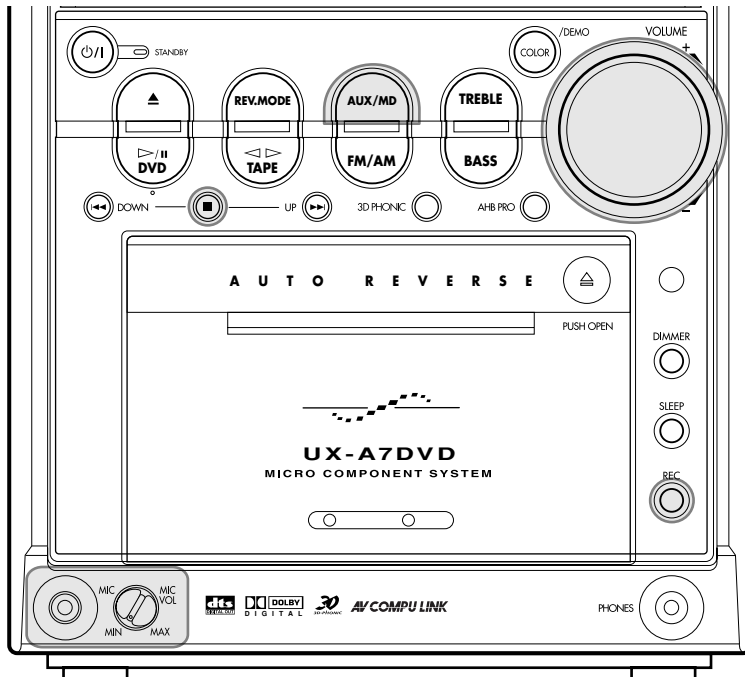



## Singing Along (Karaoke)

You can enjoy singing along (Karaoke) by using the microphone.

### IMPORTANT:

- Always set the MIC VOL control to MIN when connecting or disconnecting the microphone.
- When you do not use the microphone, keep the microphone unconnected.

If howling or squealing (feedback) occurs while using the microphone, take the following actions to prevent these noises.

- Adjust the MIC VOL and VOLUME controls (or VOLUME + / – on the remote control).
- Avoid pointing the microphone towards the speakers.

- 1 Rotate the MIC VOL control to MIN.
- 2 Connect the microphone (not supplied) by plugging it into the MIC jack.
- 3 Start playing the source—disc, tape or external equipment connected to the AUX/MD jacks.
  - When playing a multiplex karaoke disc, you can select the audio channel to play back. (See page 46.)
- 4 Rotate the MIC VOL and VOLUME controls (or VOLUME + / – on the remote control) as you sing into the microphone.
  - By pressing REC, you can record your singing along if you want. (For more details, see pages 51 and 52.)

## To apply an echo to your voice

### On the remote control ONLY:

Press **DIGITAL ECHO** so that the **ECHO** indicator lights up on the display.

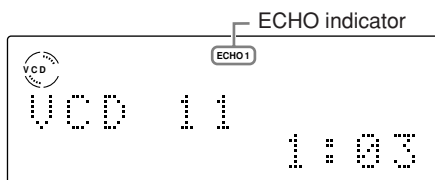

Each time you press the button, the echo level changes as follows:

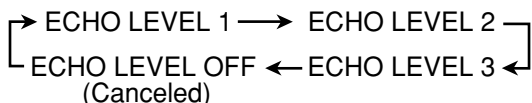

- As the number increases, a stronger echo effect applies to your voice.

## To adjust the key

You can adjust the key of the sound to fit to your voice.

- This function is available while playing back DVDs, SVCDs, VCDs, or Audio CDs loaded on the DVD player.

### On the remote control ONLY:

Press **KEY CONTROL #** or **KEY CONTROL b** to adjust the key.

The following display appears.

- You can also check your key adjustment on the TV.

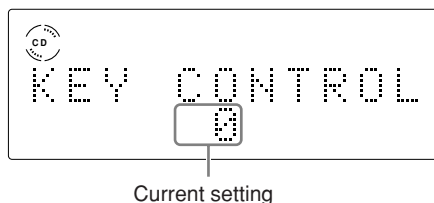

You can adjust the key within the range from “–6” to “+6” by 1 step.

To raise the key, press **KEY CONTROL #**.

To lower the key, press **KEY CONTROL b**.

To cancel the key control, set the key to “0” by pressing **KEY CONTROL #** or **KEY CONTROL b**.



**notes** When the current title or track finishes playing The key returns to “0.”



**notes** When the 3D PHONIC function (see page 48) is activated

If you set the key to other than “0,” the 3D PHONIC function is temporarily canceled even though the 3D PHONIC indicator lights up. Setting the key back to “0” makes the 3D PHONIC function activated again.

## To use the microphone only

Without any background sound, you can use your microphone and record your voice if you want.

- 1 Rotate the MIC VOL control to MIN.
- 2 Connect the microphone.
- 3 Press AUX/MD to select “AUX/MD” as the source.
  - If external equipment is connected to the AUX/MD jacks, turn it off.
- 4 Rotate the MIC VOL and VOLUME controls ( or VOLUME + / – on the remote control).
  - By pressing REC, you can record your voice if you want. (For more details, see pages 51 and 52.)

# Changing the DVD Initial Settings

The buttons emphasized in the illustration below are used and explained in the following section (pages 56 to 59).

## Remote control

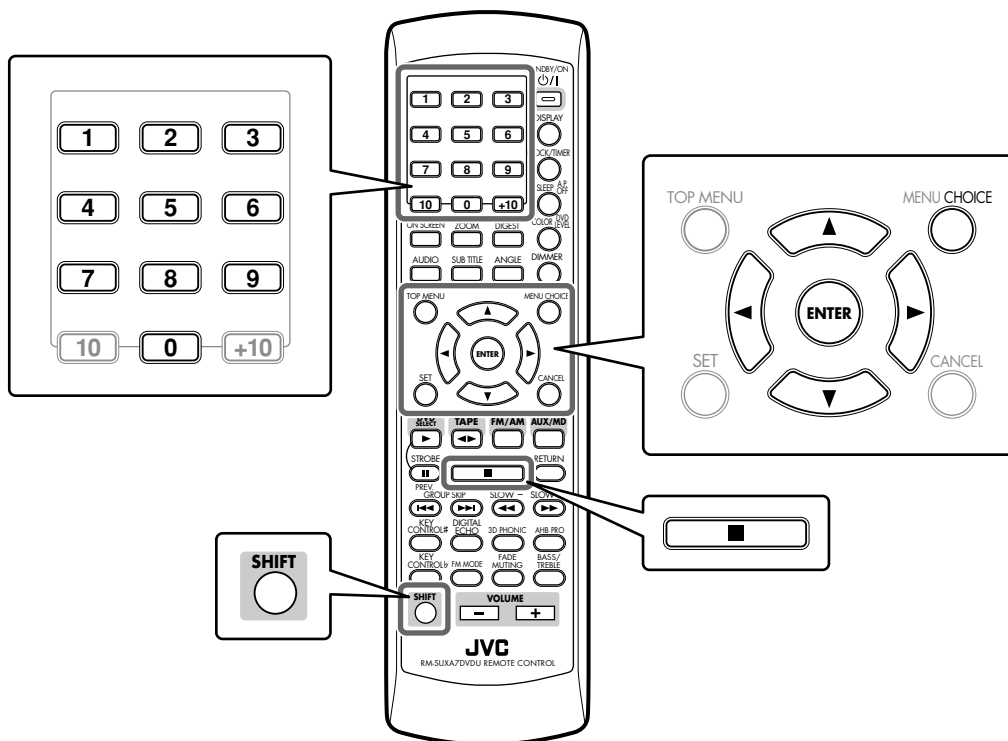

## Main unit

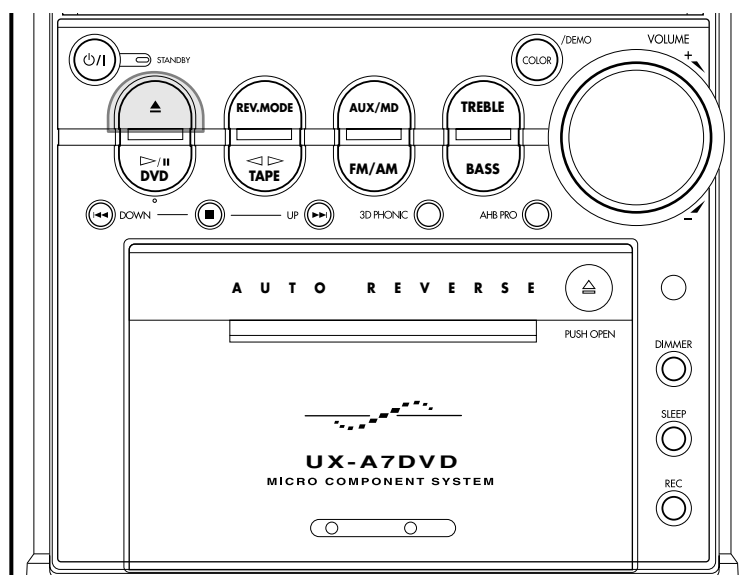

Using the setting menu, you can store the initial selection for audio languages (sound) and subtitle languages for DVD playback as well as other settings.

## Setting menu

- **LANGUAGE menu** (see page 57)

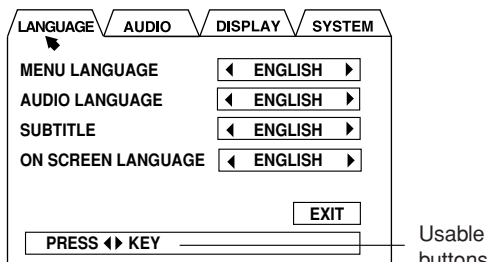

- **AUDIO menu** (see page 57)

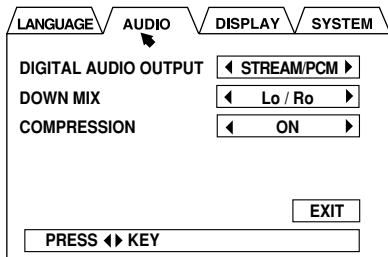

- **DISPLAY menu** (see page 58)

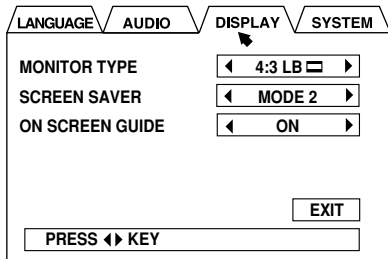

- **SYSTEM menu** (see page 58)

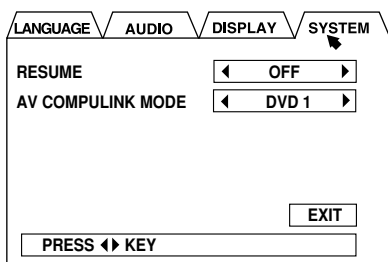

## Basic Procedure

The setting menu appears only when the selected source is the DVD player and the disc is not played back.

- When an Audio CD or MP3 disc is loaded, you cannot show the setting menu.

### On the remote control ONLY:

- 1 Press **CHOICE** while holding down **SHIFT**.  
The LANGUAGE menu appears on the TV.
- 2 Press **Cursor** **>/<** to move **▶** to the menu you want—**LANGUAGE, AUDIO, DISPLAY, or SYSTEM**.

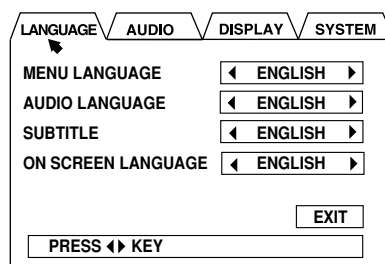

Ex.: When selecting LANGUAGE menu.

- 3 Press **Cursor** **▼/▲** to move **◀** to an item you want to set.

A selected item shows in green.

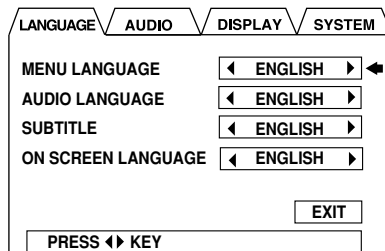

Ex.: When selecting "MENU LANGUAGE."

- 4 Press **Cursor** **>/<** to select a proper setting you want.
- 5 To set other items on the same menu, repeat steps 3 and 4.  
To set other items on the different menus, repeat steps 2 to 4.
- 6 When finished, press **Cursor** **▼** to move **◀** to "EXIT," then press **ENTER**.  
The setting menu disappears.

To exit from the setting menu any time during the above procedure, press **CHOICE** while holding down **SHIFT**. The setting menu disappears. The settings you have done up to that time will be stored.

## Changing the Initial Language Settings

On the LANGUAGE menu, you can select the following initial languages.

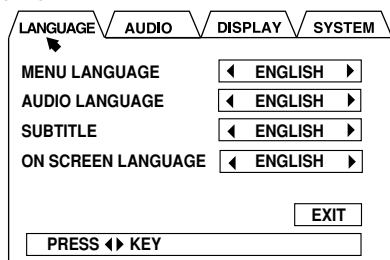

- **MENU LANGUAGE:**

Select the initial language for the DVD disc menu. Selectable languages—ENGLISH, SPANISH, FRENCH, CHINESE, GERMAN, ITALIAN, JAPANESE, AA – ZU (Language code: See page 69.)

- **AUDIO LANGUAGE:**

Select the initial language for audio sound language. Selectable languages—ENGLISH, SPANISH, FRENCH, CHINESE, GERMAN, ITALIAN, JAPANESE, AA – ZU (Language code: See page 69.)

- **SUBTITLE:**

Select the initial language for subtitles. Selectable languages—ENGLISH, SPANISH, FRENCH, CHINESE, GERMAN, ITALIAN, JAPANESE, AA – ZU (Language code: See page 69.)

- **ON SCREEN LANGUAGE:**

Select the language for the on-screen menus and indications. (See also page 13.) Selectable languages—ENGLISH, 中国語 (Chinese), ESPAÑOL (Spanish)



The original language will be selected as the initial language regardless of your setting in the following case:

- If the language you have selected is not recorded on the disc.
- If the disc is programmed to be played back in the original language.

## Changing the Various Audio Settings

On the AUDIO menu, you can change the following sound settings.

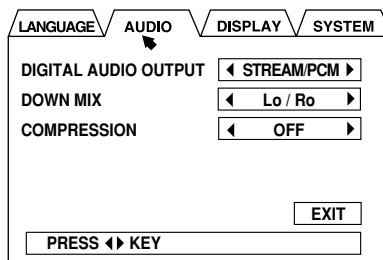

- **DIGITAL AUDIO OUTPUT:**

Set the output signal type through the DVD OPTICAL DIGITAL OUT terminal. (See also page 16.)

- Select “STREAM/PCM” when connecting an amplifier or a decoder compatible with Dolby Digital, DTS\*, and MPEG Multichannel.
- Select “PCM ONLY” when connecting an amplifier compatible only with Linear PCM, or a digital recording device such as an MD recorder, DAT deck, etc.
- Select “DOLBY DIGITAL/PCM” when connecting an amplifier or a decoder compatible only with Dolby Digital.

\* This unit does not have the DTS decoding function. To listen to DTS encoded sound, connect a DTS decoder or a DTS compatible amplifier.

- **DOWN MIX:**

When playing a DVD whose audio sound is recorded with the multichannel surround, this unit properly converts the sound signals into 2-channels. Set this item according to your audio system.

- Select “Lt/Rt” when connecting an amplifier with the surround decoder.
- Select “Lo/Ro” when listening to the playback sound through the speaker connected to this unit or when recording on this unit. Also select “Lo/Ro” when connecting an amplifier without the surround decoder or a digital recording device.



### More about DOWN MIX

- The DOWN MIX function does not work when the 3D PHONIC function is activated. (See page 48.)
- The DOWN MIX setting does not affect DTS signals.

### • COMPRESSION:

When listening to the sound with only Dolby Digital, you can produce a powerful sound even at a low volume level by compressing the dynamic range (difference between the maximum and minimum sound levels).

- Select “**ON**” when you want to apply the compression effect (useful late at night).
- Select “**OFF**” when you want surround sound with its full dynamic range (no effect applied).



#### More about COMPRESSION

- The COMPRESSION function does not work when the 3D PHONIC function is activated. (See page 48.)
- The COMPRESSION function does not affect digital signals output through the DVD OPTICAL DIGITAL OUT terminal.

## Changing the Display Settings

On the DISPLAY menu, you can change the following display settings.

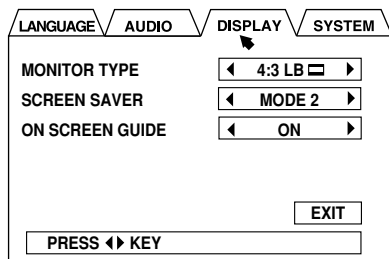

### • MONITOR TYPE:

Set the monitor type to use while playing back a DVD recorded with 16:9 wide screen video signal. (See also page 15.)

- Select “**4:3 LB (Letter Box)** ” when viewing on a TV whose aspect ratio is 4:3.  
While viewing a wide screen picture, the black bars appear on the top and the bottom of the screen.
- Select “**16:9 WIDE**” when viewing on a TV whose aspect ratio is 16:9.
- Select “**4:3 PS (Pan Scan)** ” when viewing on a TV whose aspect ratio is 4:3.  
While viewing a wide screen picture, the black bars do not appear; however, a portion of the left and right edges of the picture will not show on the screen.

### • SCREEN SAVER:

Select the screen saver to prevent the TV monitor from burning out. (See page 28.)

- Select “**MODE 1**” to activate the screen saver by making the TV screen dark.
- Select “**MODE 2**” to activate the screen saver by showing the original screen-saver.
- Select “**OFF**” to deactivate this function.

### • ON SCREEN GUIDE:

By watching the on-screen guide icons shown on the TV screen, you can see what you are doing while operating the DVD player. (See page 28.)

- Select “**ON**” to show the on-screen guide icons.
- Select “**OFF**” to deactivate this function.

## Changing the System Settings

On the SYSTEM menu, you can change the following settings.

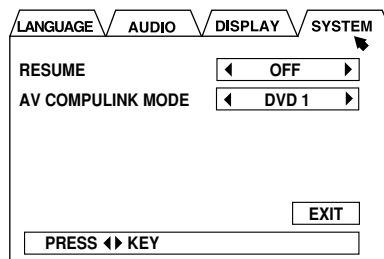

### • RESUME:

This unit can store the stop-point where DVD, SVCD or VCD playback stops. When you press DVD SELECT ► (or DVD ▷/|| on the main unit) to start playback again, it starts from where it has been stopped—Resume play.

- Pressing DVD ▲ to eject the disc erases the stored position.
- Select “**ON**” to activate Resume play.
- Select “**OFF**” to deactivate Resume play. Playback always starts from the beginning of a disc.

### • AV COMPULINK MODE:

When connecting this unit to a JVC TV with the AV COMPU LINK remote control system, select the proper setting. See page 65 for more details.  
Selectable modes—“DVD 1,” “DVD 2,” and “DVD 3.”

## Limiting Playback of DVD—Parental Lock

Using this function, you can restrict playback of DVD containing violent scenes (and those not suitable for your family members).

- This function is only possible for the DVDs containing such rating level information—Level 1 (most restrictive) to Level 8 (least restrictive).

### Setting the parental lock

You can set the parental lock only when a DVD is loaded and playback is stopped.

#### On the remote control ONLY:

#### 1 Press ENTER while holding down ■.

The PARENTAL LOCK screen appears on the TV.

- When you set the parental lock for the first time, ◀ points to “Country Code.” (Go to step 3.)
- When you change the parental lock settings, ◀ points to “PASSWORD.” (Go to step 2.)

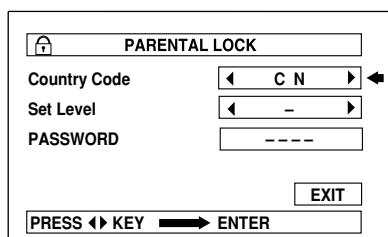

#### 2 Press the number buttons (0 – 9) to enter the current password (4 digits), then press ENTER.

- ◀ moves to “Country Code.”
- If you enter the wrong password, “WRONG! RETRY...” appears. Enter the correct password.

#### 3 Press Cursor ▶/◀ repeatedly to select a proper country code, then press ENTER.

- ◀ moves to “Set Level.”
- For country code list, see pages 70 and 71.

#### 4 Press Cursor ▶/◀ repeatedly to select a parental lock level, then press ENTER.

- ◀ moves to “PASSWORD.”
- Each time you press the button, the parental lock level changes as follows.  
You can play back only the DVD whose rating level is less than the level you set.

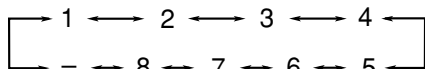

- If you do not want to make any restriction, select “-.”

#### 5 Press the number buttons (0 – 9) to enter a new password (4 digits), then press ENTER.

- ◀ moves to “EXIT.”

#### 6 Press ENTER.

- The parental lock level is set and the PARENTAL LOCK screen disappears.

To exit from the PARENTAL LOCK screen any time during the above procedure, press ENTER while holding down ■.



#### When you set the parental lock

- If you exit from the PARENTAL LOCK screen before finishing step 5, the setting you have made or changed is not stored. Repeat from step 1 again.
- If you enter the wrong password 3 times in step 2, ◀ moves to “EXIT” and Cursor ▲ and ▼ do not work. Press ENTER to exit from the PARENTAL LOCK screen, then repeat from step 1 again.
- If you forget your password, enter “8888.”

### Unlocking the Parental Lock Temporarily

Some discs cannot be played back at all when the parental lock is set. If you insert such a disc and try to play it, the following PARENTAL LOCK screen appears on the TV. You can unlock the parental lock setting temporarily on this screen.

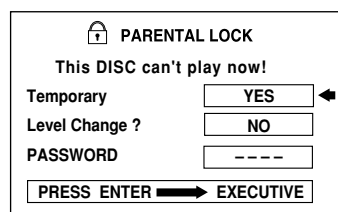

#### 1 Press Cursor ▲/▼ to select “YES,” then press ENTER.

- ◀ moves to “PASSWORD.”
- When selecting “NO,” press DVD ▲ to remove the disc.

#### 2 Press the number buttons (0 – 9) to enter the current password (4 digits).

- The parental lock is temporarily unlocked and playback starts.
- If you enter the wrong password, “WRONG! RETRY...” appears. Enter the correct password.



#### If you enter the wrong password 3 times

- ◀ moves to “NO” and Cursor ▲ and ▼ do not work. Press DVD ▲ to remove the disc.
- If you forget your password, enter “8888.”

# Using the Timers

The buttons emphasized in the illustration below are used and explained in the following section (pages 61 to 64).

## Remote control

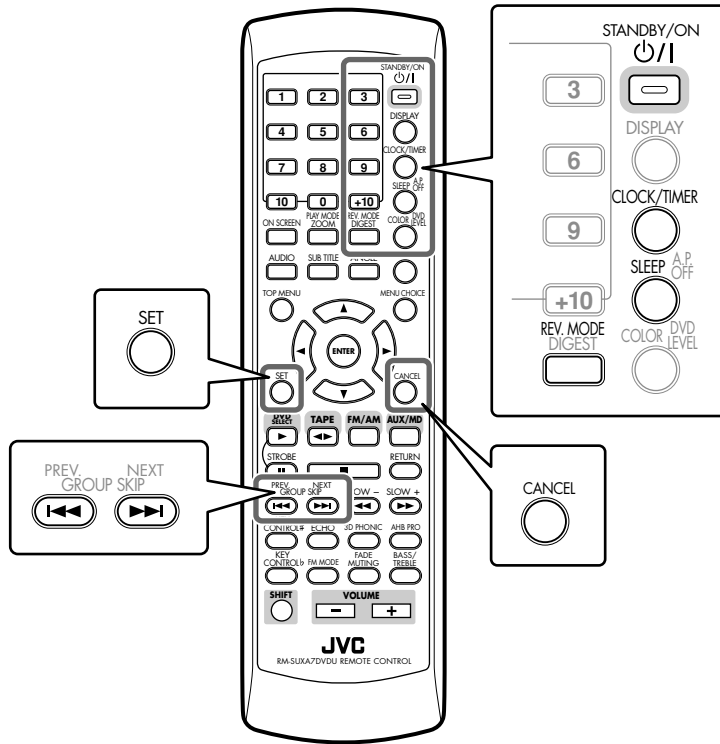

## Main unit

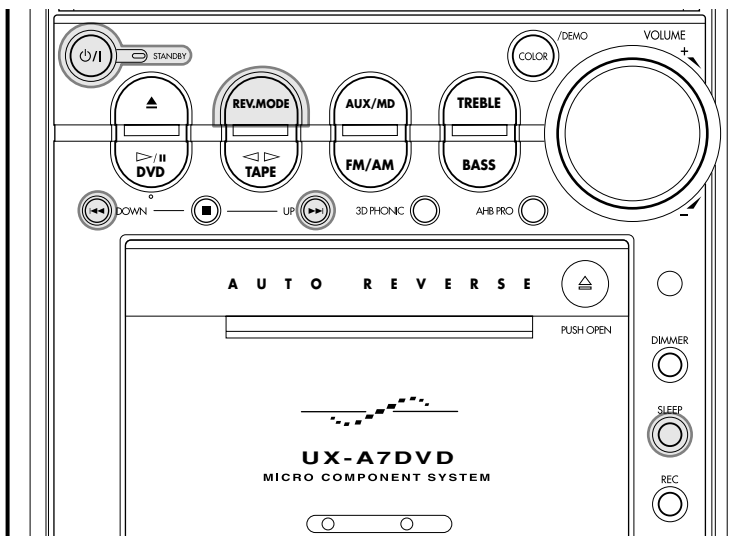

Three timers are available—Recording Timer, Daily Timer and Sleep Timer.

- Before using these timers, make sure the built-in clock is set correctly (see page 17).
- When using the tuner as the source, preset stations in advance (see page 26).

## Using the Recording Timer

With the Recording Timer, you can make an unattended recording.

- You can set the Recording Timer whether the unit is turned on or in standby mode.
- To correct a misentry any time during the setting process, press CANCEL.
- To exit from the timer setting mode during the setting process, press CLOCK/TIMER repeatedly until the source indication appears.
- When you want to record onto both sides of a tape, you can set the reverse mode to do so. Recording automatically stops after recording in the ◀ direction. Therefore, make sure that the tape direction is ▶ when recording with the reverse mode on.

### How the Recording Timer actually works

The unit automatically turns on, muting the volume, and starts recording on the tape when the timer-on time comes. Then, when the timer-off time comes, the unit automatically turns off (stands by).

The Recording Timer works only once, but the timer settings remain stored in memory until you reset them or unplug the AC power cord.

#### 1 Press CLOCK/TIMER repeatedly until “REC TIMER” appears in the main display.

The timer (⌚) indicator lights up and the REC indicator starts flashing on the display.

```

REC TIMER
ON? → SET
    ↓
OFF? → CANCEL
  
```

- Each time you press the button, the timer mode changes as follows:

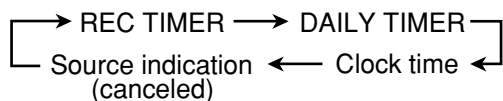

#### 2 Press SET.

The source name flashes in the main display.

#### 3 Select the source to record.

- 1) Press ▶▶ or ◀◀ repeatedly to select the source.
  - Each time you press the button, the source changes as follows:

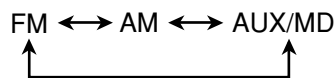

- When you select “FM” or “AM,” press SET, then select a preset number by pressing ▶▶ or ◀◀.
- When you select “AUX/MD,” set the timer function of the external component as well.

- 2) Press SET.

The hour digit of the timer-on time starts flashing.

#### 4 Press REV. MODE to select the reverse mode.

- When setting the Recording Timer while the unit is in standby mode, you cannot change the reverse mode even if you press REV. MODE.

In this case, the recording will start in the current reverse mode.

- Each time you press the button, the reverse mode changes as follows:

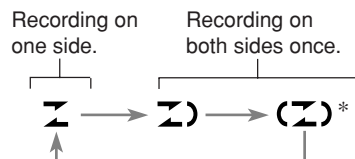

- \* (Z) will be shown during recording when you select (Z).

#### 5 Set the timer-on time.

- 1) Press ▶▶ or ◀◀ repeatedly to adjust the hour. You can adjust the hour using the number buttons.
- 2) Press SET. The minute digit starts flashing.
- 3) Press ▶▶ or ◀◀ repeatedly to adjust the minute. You can adjust the minute using the number buttons.

Ex.: When you set timer-on time to 11:30.

```

REC TIMER
ON 11:30
  
```

- 4) Press SET.

The hour digit of the timer-off time starts flashing.





**6** Set the timer-off time.

- 1) Press **▶▶|** or **|◀◀** repeatedly to adjust the hour.  
You can adjust the hour using the number buttons.
- 2) Press **SET**.  
The minute digit starts flashing.
- 3) Press **▶▶|** or **|◀◀** repeatedly to adjust the minute.  
You can adjust the minute using the number buttons.



Ex.: When you set timer-off time to 13:00.

- 4) Press **SET**.  
The REC indicator stops flashing and remains lit.  
The contents of this setting appear in the main display for your confirmation.

**7** Press **STANDBY/ON**  (or  on the main unit) to turn off the unit if necessary.

If the unit is already turned on when the timer-on time comes

The Recording Timer has no affect at all.

About 20 seconds before the timer-on time, the REC indicator and “REC TIMER STANDBY” start flashing on the display.

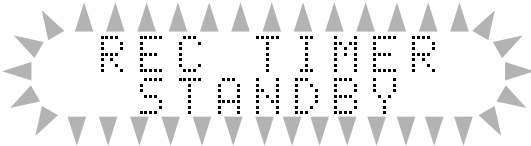



When you press **■** while the Recording Timer works

The recording stops but the timer function is not canceled. The unit automatically turns off (stands by) when the timer-off time comes.

**To turn off the Recording Timer after its setting is done**

- 1 Press **CLOCK/TIMER** repeatedly until “REC TIMER” appears in the main display.
- 2 Press **CANCEL**.  
The timer (  ) and REC indicators go off from the display.

**To turn on the Recording Timer again**

- 1 Press **CLOCK/TIMER** repeatedly until “REC TIMER” appears in the main display.
- 2 Press **SET** repeatedly until the settings are shown in the main display for your confirmation.  
The timer (  ) and REC indicators light up on the display.

**Using the Daily Timer**

With the Daily Timer, you can wake up to your favorite music or radio program.

- You can set the Daily Timer whether the unit is turned on or in standby mode.
- To correct a misentry any time during the setting process, press **CANCEL**.
- To exit from the timer setting mode during the setting process, press **CLOCK/TIMER** repeatedly until the source indication appears.

**How the Daily Timer actually works**

The unit automatically turns on, and starts playing the specified source when the timer-on time comes. Then, when the timer-off time comes, the unit automatically turns off (stands by).

The Daily Timer repeats every day, and the timer settings remain stored in memory until you reset them or unplug the AC power cord.

**1** Press **CLOCK/TIMER** repeatedly until “DAILY TIMER” appears in the main display.

The timer (  ) indicator lights up and the DAILY indicator starts flashing on the display.

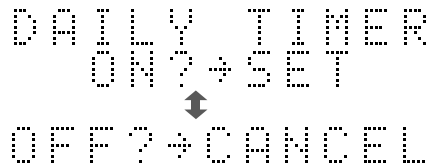

- Each time you press the button, the timer mode changes as follows:

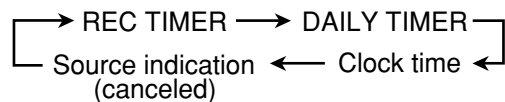
**2** Press **SET**.

The source name flashes in the main display.

Continued next page 

### 3 Select the source to play back.

- 1) Press **▶▶** or **◀◀** repeatedly to select the source.
  - Each time you press the button, the source changes as follows:

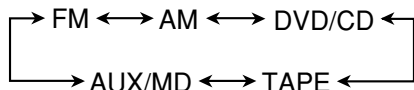

- You can also use the source selecting buttons.
- **When you select “DVD/CD” or “TAPE,”** prepare it for playing back.
- **When you select “FM” or “AM,”** press SET, then select a preset number by pressing **▶▶** or **◀◀**.
- **When you select “AUX/MD,”** set the timer function of the external component as well.

- 2) Press SET.  
The hour digit of the timer-on time starts flashing.

### 4 Set the timer-on time.

- 1) Press **▶▶** or **◀◀** repeatedly to adjust the hour.  
You can adjust the hour using the number buttons.
- 2) Press SET.  
The minute digit starts flashing.
- 3) Press **▶▶** or **◀◀** repeatedly to adjust the minute.  
You can adjust the minute using the number buttons.

DAILY TIMER  
ON 7:00

Ex.: When you set timer-on time to 7:00.

- 4) Press SET.  
The hour digit of the timer-off time starts flashing.

### 5 Set the timer-off time.

- 1) Press **▶▶** or **◀◀** repeatedly to adjust the hour.  
You can adjust the hour using the number buttons.
- 2) Press SET.  
The minute digit starts flashing.
- 3) Press **▶▶** or **◀◀** repeatedly to adjust the minute.  
You can adjust the minute using the number buttons.

DAILY TIMER  
OFF 8:00

Ex.: When you set timer-off time to 8:00.

- 4) Press SET.  
The volume setting appears in the main display.

### 6 Adjust the volume level.

- 1) Press **▶▶** or **◀◀** repeatedly to adjust the volume level.
  - You can adjust the volume level to “—” or within the range of 0 (silent) to 40 (maximum).
  - When you select “VOLUME —,” the volume is set to the current volume level.

DAILY TIMER  
VOLUME

- 2) Press SET.  
The DAILY indicator stops flashing and remains lit. The contents of this setting appear in the main display for your confirmation.

### 7 Press STANDBY/ON $\odot$ /I (or $\odot$ /I on the main unit) to turn off the unit if necessary.



**notes** If the unit is already turned on when the timer-on time comes

The Daily Timer has no affect at all.

About 20 seconds before the timer-on time, the DAILY indicator and “DAILY TIMER STANDBY” start flashing on the display.

DAILY TIMER  
STANDBY

#### To turn off the Daily Timer after its setting is done

- 1 Press CLOCK/TIMER repeatedly until “DAILY TIMER” appears in the main display.
- 2 Press CANCEL.  
The timer ( $\odot$ ) and DAILY indicators go off from the display.

#### To turn on the Daily Timer again

- 1 Press CLOCK/TIMER repeatedly until “DAILY TIMER” appears in the main display.
- 2 Press SET repeatedly until the settings are shown in the main display for your confirmation.  
The timer ( $\odot$ ) and DAILY indicators light up on the display.



**notes** The Daily Timer will be canceled and the unit will not turn off automatically in the following cases:

- When you change the source.
- When you turn off the Daily Timer.

## Using the Sleep Timer

With the Sleep Timer, you can fall asleep to your favorite music or radio program.

- You can set the Sleep Timer when the unit is turned on.

### How the Sleep Timer actually works

The unit automatically turns off after the specified length of time passes.

#### 1 Press SLEEP.

The timer (⌚) and SLEEP indicators start flashing on the display.

“SLEEP 10” appears in the main display for a while.

SLEEP 10

- Each time you press the button, the length of time changes as follows:

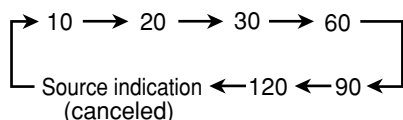

#### 2 Press SET or wait for about 5 seconds.

The illumination of the electronic swing panel and display window dim.

The timer (⌚) and SLEEP indicators stop flashing and remain lit.

To check the remaining time until shut-off time, press SLEEP once. The remaining time until shut-off time appears for about 5 seconds.

To change the shut-off time, press SLEEP repeatedly until the length of time you want appears.

To cancel the setting, press SLEEP repeatedly until the current source indication appears in the main display. The timer (⌚) and SLEEP indicators go off.



The Sleep Timer will be also canceled in the following cases:

- When you turn off the unit.
- When you operate other timer settings.
- When you adjust the clock.



The Sleep Timer and the Auto Power Off (see page 19) can be used at the same time.

### To sleep with the Sleep Timer and wake up with the Daily Timer

The unit turns off when the shut-off time comes (set by the Sleep Timer), and turns on when the timer-on time (set by the Daily Timer) comes.

- 1 Set the Daily Timer as explained on pages 62 and 63.
- 2 Start playing back any source you want to listen to before sleep.
- 3 Set the Sleep Timer.

#### Timer Priority

Since each timer can be set separately, you may wonder what happens if the setting for these timers overlaps. Here are the priorities for each timer.

- If the Recording Timer is set to come on earlier than the Daily Timer:

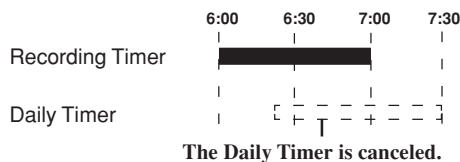

- If the Daily Timer is set to come on earlier than the Recording Timer:

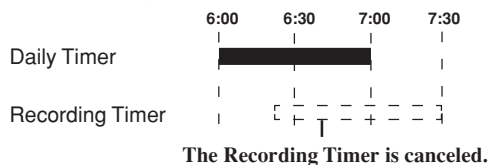

- If the Recording and Daily Timer is set to come on at the same time:

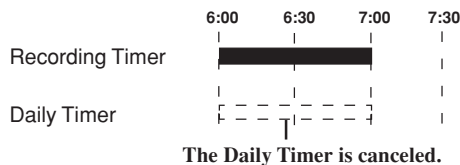

- If the Recording or Daily Timer is set to come on earlier than the shut-off time of the Sleep Timer:

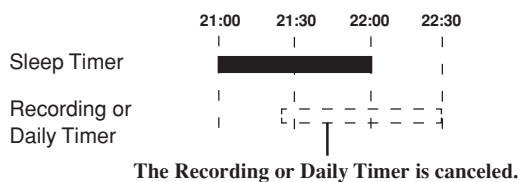

# Using AV COMPU LINK Control System

The AV COMPU LINK control system allows you to use JVC's TV with simple operations.

To use AV COMPU LINK control system, you need to connect this unit and a TV through the AV COMPU LINK terminals.

## AV COMPU LINK Connection

Connect JVC video components with AV COMPU LINK jack by using a cord with monaural mini-plugs (not supplied).

- You need to set "AV COMPULINK MODE" in the SYSTEM menu correctly to use AV COMPU LINK control system. (See page 58.)
- Refer also to the manual supplied with your TV.

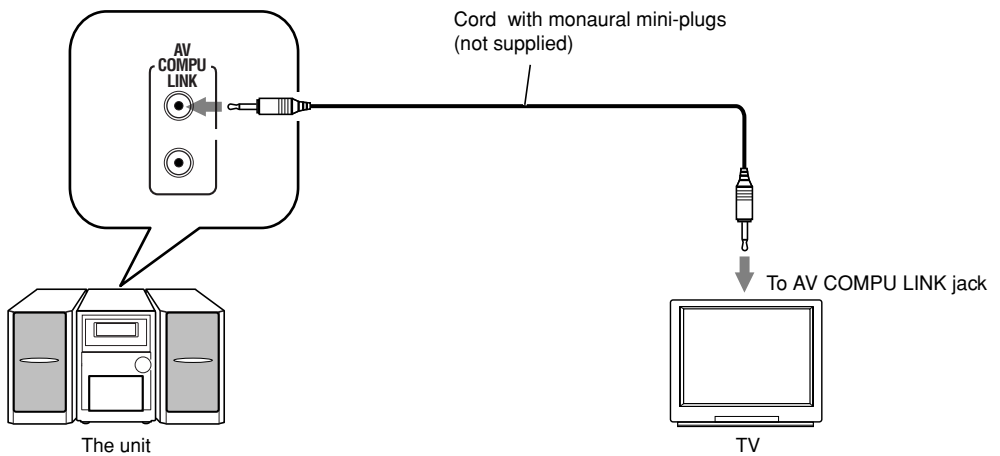

Set "AV COMPULINK MODE" in the SYSTEM menu as follows.

- Select "DVD 1" (initial setting) when connecting to the VIDEO-3 (DVD) input jack of the TV.
- Select "DVD 2" when connecting to the VIDEO-1 input jack of the TV.
- Select "DVD 3" when connecting to the VIDEO-2 input jack of the TV.



You can connect a JVC video component that has AV COMPU LINK II, AV COMPU LINK III, or AV COMPU LINK EX jack can be connected to this unit.

## One-touch DVD play

Simply by starting playback on the unit, the TV automatically turns on and changes the input mode to the appropriate position so that you can view the playback picture.

- The TV does not automatically turn off even if you turn off the unit.



When the main power of the TV is off or the power cord of the TV is unplugged, you cannot use the one-touch play.

# Maintenance

To get the best performance of the unit, keep your discs, tapes and mechanism clean.

## General Notes

In general, you will have the best performance by keeping your discs, tapes and the mechanism clean.

- Store discs and tapes in their cases, and keep them in cabinets or on shelves.
- Keep the electronic swing panel closed when not in use.

## Cleaning the unit

### • Stains on the unit

Should be wiped off with a soft cloth. If the unit is heavily stained, wipe it with a cloth soaked in water-diluted neutral detergent and wrung well, then wipe clean with a dry cloth.

### • Since the unit may deteriorate in quality, become damaged or get its paint peeled off, be careful about the following:

- DO NOT wipe it with a hard cloth.
- DO NOT wipe it strong.
- DO NOT wipe it with thinner or benzine.
- DO NOT apply any volatile substance such as insecticides to it.
- DO NOT allow any rubber or plastic to remain in contact with it for a long time.

## Handling cassette tapes

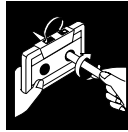

- If the tape is loose in its cassette, take up the slack by inserting a pencil in one of the reels and rotating.
- If the tape is loose, it may get stretched, cut, or caught in the cassette.



- Be careful not to touch the tape surface.



- Avoid the following places to store the tape:
  - In dusty places
  - In direct sunlight or heat
  - In moist areas
  - On a TV or speaker
  - Near a magnet

## Handling discs



- Remove the disc from its case by holding it at the edge while pressing the center hole lightly.
- Do not touch the shiny surface of the disc, or bend the disc.
- Put the disc back in its case after use to prevent warping.

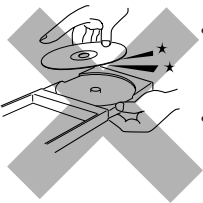

- Be careful not to scratch the surface of the disc when placing it back in its case.
- Avoid exposure to direct sunlight, temperature extremes, and moisture.



### To clean the disc

Wipe the disc with a soft cloth in a straight line from center to edge.



DO NOT use any solvent—such as conventional record cleaner, spray, thinner, or benzine—to clean the disc.

# Troubleshooting

If you are having a problem with your unit, check this list for a possible solution before calling for service.

If you cannot solve the problem from the hints given here, or the unit has been physically damaged, call a qualified person, such as your dealer, for service.

	Symptom	Possible Cause	Action
General	Power does not come on.	The power cord is not connected to an AC outlet.	Insert the plug into the socket.
	No sound is heard from the speakers.	<ul style="list-style-type: none"> <li>• Connections are incorrect or loose.</li> <li>• A pair of headphones is connected.</li> </ul>	<ul style="list-style-type: none"> <li>• Check all connections and make corrections. (See pages 8 to 12.)</li> <li>• Unplug the headphones from the PHONES jack.</li> </ul>
	Unable to operate the remote control.	<ul style="list-style-type: none"> <li>• The path between the remote control and the remote sensor on the unit is blocked.</li> <li>• The batteries have lost their charge.</li> <li>• You are using the remote control too far from the main unit.</li> </ul>	<ul style="list-style-type: none"> <li>• Remove the obstruction.</li> <li>• Replace the batteries. (See page 8.)</li> <li>• Signals cannot reach the remote sensor. Move close to the main unit.</li> </ul>
	Operations are disabled.	The built-in microprocessor has malfunctioned due to external electrical interference.	Unplug the AC power cord then plug it back in.
	The unit is shut off right after turning it on or starting playback.	The speaker cords are short-circuited or an internal malfunction with the unit occurred.	Unplug the AC power cord, check the connection of the speaker cords, then plug the AC power cord again. If the symptom still persists, consult your dealer.
Tuner	Poor radio reception.	<ul style="list-style-type: none"> <li>• The antenna is not connected correctly.</li> <li>• The AM loop antenna is too close to the unit.</li> <li>• The FM antenna is not properly extended and positioned.</li> </ul>	<ul style="list-style-type: none"> <li>• Reconnect the antenna securely.</li> <li>• Change the position and direction of the AM loop antenna.</li> <li>• Extend FM antenna and orient to the best reception position.</li> </ul>
Disc	Loaded disc cannot be ejected.	<ul style="list-style-type: none"> <li>• The main AC power cord is not plugged in.</li> <li>• The Disc Lock function is in use.</li> </ul>	<ul style="list-style-type: none"> <li>• Plug in the AC power cord.</li> <li>• Cancel the Disc Lock function. (See page 23.)</li> </ul>
	The disc does not play.	<ul style="list-style-type: none"> <li>• The disc is upside down.</li> <li>• The unit and disc Region Code numbers are incompatible.</li> <li>• Parental lock is in use.</li> </ul>	<ul style="list-style-type: none"> <li>• Put the disc in with the label side up.</li> <li>• Replace the disc. (See page 28.)</li> <li>• Unlock the parental lock. (See page 59.)</li> </ul>
	“ERROR” appears in the main display and the disc cannot be played.	You are trying to play a CD-R/RW which has not been “finalized.”	It cannot be played. Replace the disc. (You can play only “finalized” CD-R/RWs.)
	Video and audio are distorted.	<ul style="list-style-type: none"> <li>• The disc is dirty or scratched.</li> <li>• A VCR is connected between the unit and the TV.</li> </ul>	<ul style="list-style-type: none"> <li>• Clean or replace the disc. (See pages 28 and 66.)</li> <li>• Connect the unit and TV directly. (See page 10.)</li> </ul>

Symptom	Possible Cause	Action		
No picture appears on the screen.	<ul style="list-style-type: none"> <li>The video cord is not connected correctly.</li> <li>Incorrect color system is selected.</li> <li>An incorrect input has been selected on the TV or monitor.</li> </ul>	<ul style="list-style-type: none"> <li>Connect the video cord correctly.</li> <li>Select correct color system. (See page 10.)</li> <li>Select the correct input on the TV or monitor.</li> </ul>	Disc	
Picture does not fit the television screen.	<ul style="list-style-type: none"> <li>“MONITOR TYPE” is not set correctly.</li> <li>The TV is not set correctly.</li> </ul>	<ul style="list-style-type: none"> <li>Select the monitor type correctly. (See pages 15 and 58.)</li> <li>Set the TV correctly.</li> </ul>		
No sound is heard.	<ul style="list-style-type: none"> <li>You are playing a disc encoded with DTS.</li> <li>MP3 disc is recorded with “packet writing.”</li> </ul>	<ul style="list-style-type: none"> <li>This unit cannot output DTS sound without connecting a decoder compatible with DTS (with “DIGITAL AUDIO OUTPUT” to “STREAM/PCM”—See page 57).</li> <li>It cannot be played. Replace the disc.</li> </ul>		
No subtitle appears on the display though you have selected the initial subtitle language.	Some DVDs are programmed always to display no subtitle initially.	Press SUB TITLE on the remote control after starting play. (See page 46.)		
Audio language is different from the one you have selected as the initial audio language.	Some DVDs are programmed always to use the original language initially.	Press AUDIO on the remote control after starting play. (See page 46.)		
While a DVD is played back, the sound is small as compared with other discs.	The audio sound of DVD is recorded at a lower level than the sounds of other discs such as VCDs or Audio CDs.	Increase the sound level of DVD playback. (See page 30.)		
Specific files (tracks) on an MP3 disc are not played.	Files other than MP3 are included in the disc.	They cannot be played.		
A particular function does not work during playback of an MP3 disc.	For MP3 discs, some functions do not work.	About unavailable functions for MP3 discs, see page 32.		
Tape sound is at a very low level and the sound quality is degraded.	The tape head is dirty and magnetized.	Clean and demagnetize the head. (See page 50.)		Tape
The cassette holder does not open or close.	Power supply from the AC power cord has been cut off while the tape was running.	Turn on the unit.		
Impossible to record on a tape.	Small tabs on the back of the cassette are removed.	Cover the holes with adhesive tape. (See page 50.)		

# Table of Language Codes

This table is used when you select an audio language or a subtitle language (see page 46) and when you select a language in the LANGUAGE menu (see page 57).

Code	Language	Code	Language	Code	Language
AA	Afar	IK	Inupiak	RN	Kirundi
AB	Abkhazian	IN	Indonesian	RO	Rumanian
AF	Afrikaans	IS	Icelandic	RU	Russian
AM	Ameharic	IW	Hebrew	RW	Kinyarwanda
AR	Arabic	JI	Yiddish	SA	Sanskrit
AS	Assamese	JW	Javanese	SD	Sindhi
AY	Aymara	KA	Georgian	SG	Sangho
AZ	Azerbaijani	KK	Kazakh	SH	Serbo-Croatian
BA	Bashkir	KL	Greenlandic	SI	Singhalese
BE	Byelorussian	KM	Cambodian	SK	Slovak
BG	Bulgarian	KN	Kannada	SL	Slovenian
BH	Bihari	KO	Korean (KOR)	SM	Samoan
BI	Bislama	KS	Kashmiri	SN	Shona
BN	Bengali, Bangla	KU	Kurdish	SO	Somali
BO	Tibetan	KY	Kirghiz	SQ	Albanian
BR	Breton	LA	Latin	SR	Serbian
CA	Catalan	LN	Lingala	SS	Siswati
CO	Corsican	LO	Laothian	ST	Sesotho
CS	Czech	LT	Lithuanian	SU	Sundanese
CY	Welsh	LV	Latvian, Lettish	SV	Swedish
DA	Danish	MG	Malagasy	SW	Swahili
DZ	Bhutani	MI	Maori	TA	Tamil
EL	Greek	MK	Macedonian	TE	Telugu
EO	Esperanto	ML	Malayalam	TG	Tajik
ET	Estonian	MN	Mongolian	TH	Thai
EU	Basque	MO	Moldavian	TI	Tigrinya
FA	Persian	MR	Marathi	TK	Turkmen
FI	Finnish	MS	Malay (MAY)	TL	Tagalog
FJ	Fiji	MT	Maltese	TN	Setswana
FO	Faroese	MY	Burmese	TO	Tonga
FY	Frisian	NA	Nauru	TR	Turkish
GA	Irish	NE	Nepali	TS	Tsonga
GD	Scots Gaelic	NL	Dutch	TT	Tatar
GL	Galician	NO	Norwegian	TW	Twi
GN	Guarani	OC	Occitan	UK	Ukrainian
GU	Gujarati	OM	(Afan) Oromo	UR	Urdu
HA	Hausa	OR	Oriya	UZ	Uzbek
HI	Hindi	PA	Panjabi	VI	Vietnamese
HR	Croatian	PL	Polish	VO	Volapuk
HU	Hungarian	PS	Pashto, Pushto	WO	Wolof
HY	Armenian	PT	Portuguese	XH	Xhosa
IA	Interlingua	QU	Quechua	YO	Yoruba
IE	Interlingue	RM	Rhaeto-Romance	ZU	Zulu



# Table of Country/Area Codes

Continued 

This table is used when you set a country code for Parental Lock. (See page 59.)

Code	Country	Code	Country	Code	Country
AD	Andorra	CM	Cameroon	GR	Greece
AE	United Arab Emirates	CN	China	GS	South Georgia and the South Sandwich Islands
AF	Afghanistan	CO	Colombia	GT	Guatemala
AG	Antigua and Barbuda	CR	Costa Rica	GU	Guam
AI	Anguilla	CU	Cuba	GW	Guinea-Bissau
AL	Albania	CV	Cape Verde	GY	Guyana
AM	Armenia	CX	Christmas Island	HK	Hong Kong
AN	Netherlands Antilles	CY	Cyprus	HM	Heard Island and McDonald Islands
AO	Angola	CZ	Czech Republic	HN	Honduras
AQ	Antarctica	DE	Germany	HR	Croatia
AR	Argentina	DJ	Djibouti	HT	Haiti
AS	American Samoa	DK	Denmark	HU	Hungary
AT	Austria	DM	Dominica	ID	Indonesia
AU	Australia	DO	Dominican Republic	IE	Ireland
AW	Aruba	DZ	Algeria	IL	Israel
AZ	Azerbaijan	EC	Ecuador	IN	India
BA	Bosnia and Herzegovina	EE	Estonia	IO	British Indian Ocean Territory
BB	Barbados	EG	Egypt	IQ	Iraq
BD	Bangladesh	EH	Western Sahara	IR	Iran (Islamic Republic of)
BE	Belgium	ER	Eritrea	IS	Iceland
BF	Burkina Faso	ES	Spain	IT	Italy
BG	Bulgaria	ET	Ethiopia	JM	Jamaica
BH	Bahrain	FI	Finland	JO	Jordan
BI	Burundi	FJ	Fiji	JP	Japan
BJ	Benin	FK	Falkland Islands (Malvinas)	KE	Kenya
BM	Bermuda	FM	Micronesia (Federated States of)	KG	Kyrgyzstan
BN	Brunei Darussalam	FO	Faroe Islands	KH	Cambodia
BO	Bolivia	FR	France	KI	Kiribati
BR	Brazil	FX	France, Metropolitan	KM	Comoros
BS	Bahamas	GA	Gabon	KN	Saint Kitts and Nevis
BT	Bhutan	GB	United Kingdom	KP	Korea, Democratic People's Republic of
BV	Bouvet Island	GD	Grenada	KR	Korea, Republic of
BW	Botswana	GE	Georgia	KW	Kuwait
BY	Belarus	GF	French Guiana	KY	Cayman Islands
BZ	Belize	GH	Ghana	KZ	Kazakhstan
CA	Canada	GI	Gibraltar	LA	Lao People's Democratic Republic
CC	Cocos (Keeling) Islands	GL	Greenland	LB	Lebanon
CF	Central African Republic	GM	Gambia	LC	Saint Lucia
CG	Congo	GN	Guinea		
CH	Switzerland	GP	Guadeloupe		
CI	Côte d'Ivoire	GQ	Equatorial Guinea		
CK	Cook Islands				
CL	Chile				

Code	Country	Code	Country	Code	Country
LI	Liechtenstein	PE	Peru	TH	Thailand
LK	Sri Lanka	PF	French Polynesia	TJ	Tajikistan
LR	Liberia	PG	Papua New Guinea	TK	Tokelau
LS	Lesotho	PH	Philippines	TM	Turkmenistan
LT	Lithuania	PK	Pakistan	TN	Tunisia
LU	Luxembourg	PL	Poland	TO	Tonga
LV	Latvia	PM	Saint Pierre and Miquelon	TP	East Timor
LY	Libyan Arab Jamahiriya			TR	Turkey
MA	Morocco	PN	Pitcairn	TT	Trinidad and Tobago
MC	Monaco	PR	Puerto Rico	TV	Tuvalu
MD	Moldova, Republic of	PT	Portugal	TW	Taiwan
MG	Madagascar	PW	Palau	TZ	Tanzania, United Republic of
MH	Marshall Islands	PY	Paraguay		
ML	Mali	QA	Qatar	UA	Ukraine
MM	Myanmar	RE	Réunion	UG	Uganda
MN	Mongolia	RO	Romania	UM	United States Minor Outlying Islands
MO	Macau	RU	Russian Federation		
MP	Northern Mariana Islands	RW	Rwanda	US	United States
		SA	Saudi Arabia	UY	Uruguay
MQ	Martinique	SB	Solomon Islands	UZ	Uzbekistan
MR	Mauritania	SC	Seychelles	VA	Vatican City State (Holy See)
MS	Montserrat	SD	Sudan		
MT	Malta	SE	Sweden	VC	Saint Vincent and the Grenadines
MU	Mauritius	SG	Singapore		
MV	Maldives	SH	Saint Helena	VE	Venezuela
MW	Malawi	SI	Slovenia	VG	Virgin Islands (British)
MX	Mexico	SJ	Svalbard and Jan Mayen	VI	Virgin Islands (U.S.)
MY	Malaysia			VN	Viet Nam
MZ	Mozambique	SK	Slovakia	VU	Vanuatu
NA	Namibia	SL	Sierra Leone	WF	Wallis and Futuna Islands
NC	New Caledonia	SM	San Marino		
NE	Niger	SN	Senegal	WS	Samoa
NF	Norfolk Island	SO	Somalia	YE	Yemen
NG	Nigeria	SR	Suriname	YT	Mayotte
NI	Nicaragua	ST	Sao Tome and Principe	YU	Yugoslavia
NL	Netherlands	SV	El Salvador	ZA	South Africa
NO	Norway	SY	Syrian Arab Republic	ZM	Zambia
NP	Nepal	SZ	Swaziland	ZR	Zaire
NR	Nauru	TC	Turks and Caicos Islands	ZW	Zimbabwe
NU	Niue	TD	Chad		
NZ	New Zealand	TF	French Southern Territories		
OM	Oman				
PA	Panama	TG	Togo		

# Specifications

Design and specifications are subject to change without notice.

## Amplifier Section—CA-UXA7DVD

Output Power (IEC 268-3):	74 W (37 W + 37 W) at 6 $\Omega$ (10% THD)
Analog input	
AUX/MD:	Sensitivity/Impedance (at 1 kHz) 500 mV/47 k $\Omega$ (at "LEVEL 1") 200 mV/47 k $\Omega$ (at "LEVEL 2")
MIC:	1.55 mV/10 k $\Omega$
Digital output	
DVD OPTICAL DIGITAL OUT:	-21 dBm to -15 dBm (660 nm $\pm$ 30 nm)
VIDEO OUT:	
Color system:	NTSC/PAL selectable
Composite:	1 V(p-p)/75 $\Omega$
S-video:	
Y (luminance)	1 V(p-p)/75 $\Omega$
C (chrominance, burst)	0.286 V(p-p)/75 $\Omega$
Speaker Terminals:	6 $\Omega$ - 16 $\Omega$

## Tuner

FM tuning range:	87.50 MHz—108.00 MHz
AM tuning range:	531 kHz—1 710 kHz (at 9 kHz channel spacing) 530 kHz—1 710 kHz (at 10 kHz channel spacing)

## DVD player

Readable discs:	DVD VIDEO, Super Video CD, Video CD, Audio CD
Dynamic range:	98 dB
Horizontal resolution:	500 lines
Wow and flutter:	Immeasurable

## Cassette deck

Frequency response:	
Normal (type I):	60 Hz—14 000 Hz
Wow and flutter:	0.15 % (WRMS)

## General

Power requirement:	AC 220 V $\sim$ , 50 Hz
Power consumption:	
At operation:	95 W
On standby:	14 W 1.5 W (in power save mode)
Dimensions (W/H/D) (approx.):	185 mm x 265 mm x 316 mm
Mass (approx.):	6.4 kg

## Supplied accessories

See "Unpacking" on page 8.

## Speaker Section—SP-UXA7DVD

Type:	3-way bass-reflex magnetically shielded type
Speakers:	Woofer 10 cm cone x1 Midrange 4 cm cone x1 Tweeter 2 cm dome x1
Impedance:	6 $\Omega$
Frequency range:	55 Hz to 20 kHz
Sound pressure level:	85.5 dB/W•m
Dimensions (W/H/D) (approx.):	153 mm x 266 mm x 211.5 mm
Mass (approx.):	3.0 kg each



® Registered Trademark owned by VICTOR COMPANY OF JAPAN, LTD.

 EN, CS

© 2003 VICTOR COMPANY OF JAPAN, LIMITED

 0303MWMMDWJEM